

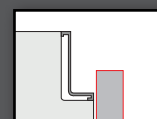

# COLORELab moderno

2024

# color lab



Neck

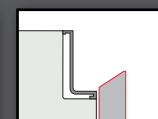

Lux



Bridge



**i** Nella versione rain riduzione in larghezza possibile solo di 15 mm su un lato o di 30 mm su due lati.  
In the rain version, width reduction only possible 15 mm on one side or 30 mm on two sides.

**ANTA:**  
DOOR:

SP:  
TH: **20** MM

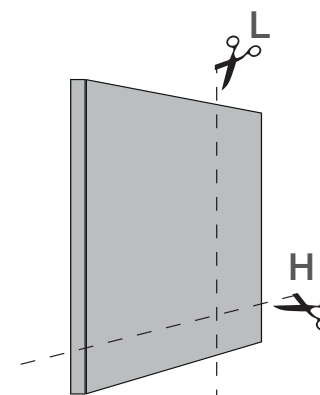
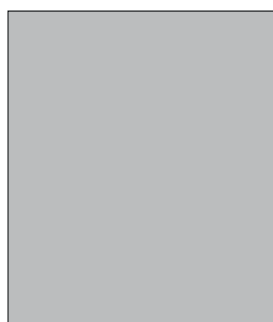

**ANTA SP.20 MM**  
**ABBINABILE CON**  
**L'INTERA COLLEZIONE**

TH. 20 MM DOOR  
MATCHABLE WITH  
THE ENTIRE COLLECTION



**CONSULTA:**  
CONSULT:

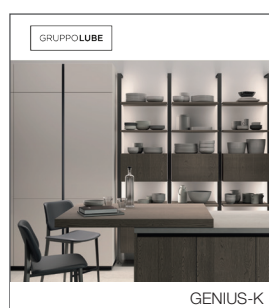
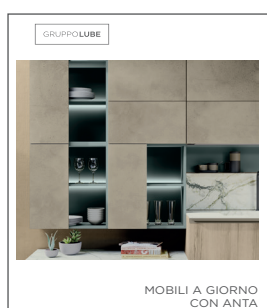

**ALTRO:**  
MORE:





## Laccato Opaco

Matt Lacquered

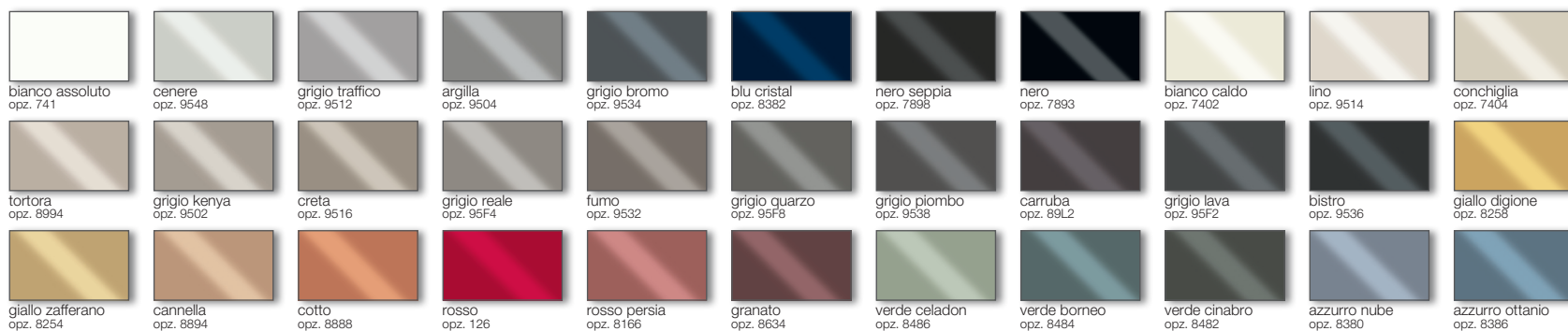

## Laccato Lucido

Glossy Lacquered



## Laccato Super Opaco

Super Matt Lacquered



## Laccato Super Opaco Rain

Rain-effect Super Matt Lacquered

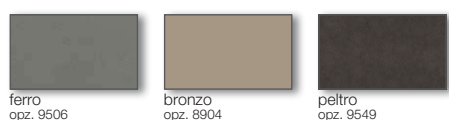

## Laccato Vintage Effetto Metallo

Vintage Metal Effect Lacquered



## MADE IN ITALY: NORMA UNI 11674

La norma tutela l'acquirente garantendo l'origine italiana e le prestazioni di sicurezza e durata del prodotto, entrambe verificate periodicamente da uno dei più importanti laboratori di prova e certificazione per il legno-arredo in Italia: COSMOB.

## MADE IN ITALY: STANDARD UNI 11674

This standard protects purchasers by guaranteeing the Italian origin, safety performance and useful life of products, both periodically verified by one of the leading testing and certification labs for wooden furnishings in Italy: COSMOB.



## GREENGUARD

Il Programma di Certificazione GREENGUARD certifica che tutte le strutture dei prodotti a marchio LUBE e CREO sono conformi agli standard più rigorosi in termini di livelli di emissione di Composti Organici Volatili (COV) emessi da mobili, superfici e vernice oltre ad altre sostanze chimiche nocive negli ambienti interni.

## GREENGUARD

The GREENGUARD certification programme certifies that all structures of LUBE and CREO products comply with the strictest standards in terms of emissions of volatile organic compounds (VOCs) from furniture, surfaces and coatings, as well as other harmful chemical substances in interior environments.



## PANNELLO ECOLOGICO

Le strutture dei mobili LUBE e CREO sono realizzate con pannelli composti da legni riciclati al 100%, certificati dal Consorzio Pannello Ecologico e con materiali a basso impatto ambientale, certificati per la bassa emissione di formaldeide.

## ECOLOGICAL PANELS

LUBE and CREO structures are created with panels made from 100% recycled wood, certified by the Eco-Panel Consortium, and from environmentally friendly materials, certified for low formaldehyde emissions.



## GRUPPO LUBE ECOLOGIC

Il Gruppo LUBE utilizza per i componenti delle cucine (tutte le strutture, alcune ante e alcuni complementi), materiale conforme al regolamento EPA TSCA TITLE VI, uno dei più severi in merito alle normative di salvaguardia ambientale.

## ECOLOGICAL PANELS

The LUBE Group uses for kitchen components (all carcasses, some doors and some accessories), material that complies with the EPA TSCA TITLE VI regulation, one of the strictest regarding environmental protection regulations.



## SOSTENIBILITÀ AMBIENTALE

Lube Industries srl è dotata di Sistemi di Gestione per l'Efficienza Ambientale, per la Qualità e per la Salute e la Sicurezza sul Lavoro, in conformità alle norme: UNI EN ISO 14001, UNI EN ISO 9001 e UNI EN ISO 45001.

## ENVIRONMENTAL SUSTAINABILITY

Lube Industries S.r.l. implements management systems for environmental efficiency, quality, and occupational health and safety, in conformity to the following standards: UNI EN ISO 14001, UNI EN ISO 9001 and UNI EN ISO 45001.



## FSC®

La certificazione FSC® rappresenta il principale meccanismo di garanzia sull'origine del legno o della carta, con questa certificazione Lube Industries ha deciso di rendere noto il suo impegno nei confronti dell'ambiente e si schiera contro il disboscamento incontrollato e il taglio illegale di foreste.

## FSC®

FSC® certification is the leading mechanism guaranteeing the origin of wood and paper. With this certification, Lube Industries has decided to demonstrate its commitment to the environment and stand against uncontrolled deforestation and illegal felling.

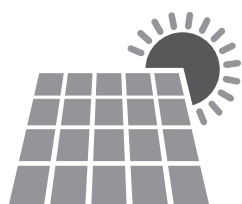

## FOTOVOLTAICO

Energia pulita per prodotti di qualità. Un impianto fotovoltaico, installato nella sede aziendale, copre la superficie di 40.800 mq ed eroga una potenza di 6,2 MWp. L'energia prodotta quotidianamente dai pannelli solari, circa 6000 KWh, è in grado di soddisfare il fabbisogno dei processi produttivi aziendali.

## PHOTOVOLTAICS

Clean energy for high-quality products. A photovoltaic plant, installed at the company headquarters, covers an area of 40,800 m2 and has a power output of 6.2 MWp. The energy generated daily by the solar panels, approximately 6,000 KWh, is enough to meet the company's production needs.

# STRUTTURE

## CARCASSES



bianco (opz.001)  
schiena e ripiano bianco  
(opz.001)  
white (opt.001)  
white back panel and shelf  
(opt.001)

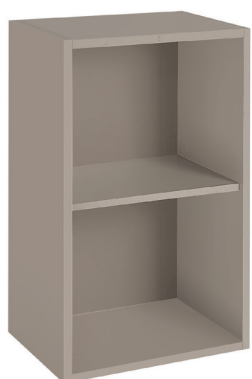

visone (opz.948M)  
schiena e ripiano visone  
(opz.948M)  
mink (opt.948M)  
mink back panel and shelf  
(opt.948M)

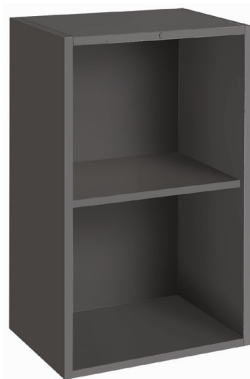

lavagna (opz.9620)  
schiena e ripiano lavagna  
(opz.9620)  
slate grey (opt.9620)  
slate grey back panel and shelf  
(opt.9620)

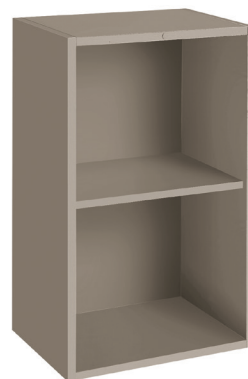

fango (opz.8860)  
schiena e ripiano fango  
(opz.8860)  
mud (opt.8860)  
mud back panel and shelf  
(opt.8860)



conchiglia (opz.8910)  
schiena e ripiano conchiglia  
(opz.8910)  
shell (opt.8910)  
shell back panel and shelf  
(opt.8910)

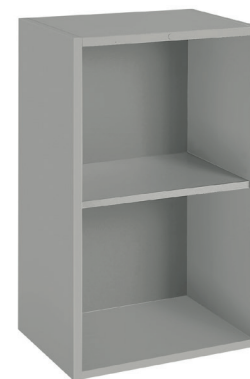

argilla (opz.9690)  
schiena e ripiano argilla  
(opz.9690)  
clay (opt.9690)  
clay back panel and shelf  
(opt.9690)



## MENSOLE P. 31-61 COME STRUTTURE

### D. 31-61 SHELVES AS CARCASSES

## MENSOLE P. 31-61 COME ANTE

### D. 31-61 SHELVES AS DOORS



bianco (opz.001)

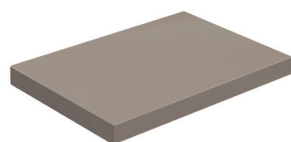

visone (opz.948M)

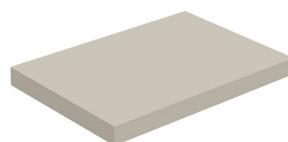

mensole laccato opaco  
matt lacquered shelves

Per le finiture vedi pagine 32 / 33 / 34  
For finishes see pages 32 / 33 / 34

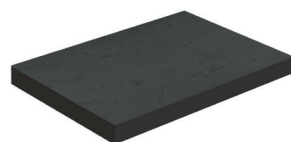

lavagna (opz.9620)

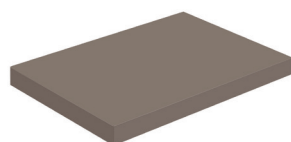

fango (opz.8860)

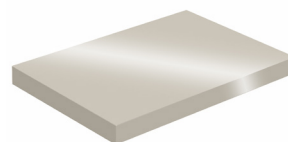

mensole laccato lucido  
glossy lacquered shelves

Per le finiture vedi pagine 36 / 37 / 38  
For finishes see pages 36 / 37 / 38

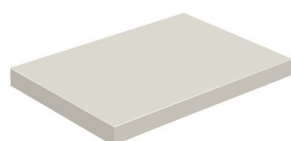

conchiglia (opz.8910)

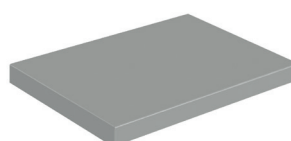

argilla (opz.9690)

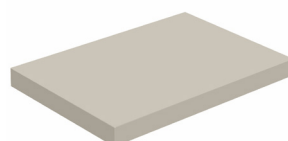

mensole laccato super opaco  
super matt lacquered shelves

Per le finiture vedi pagine 40 / 41  
For finishes see pages 40 / 41

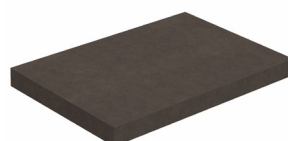

mensole laccato vintage  
effetto metallo

vintage lacquered shelves  
metal effect

Per le finiture vedi pagine 44  
For finishes see pages 44

## zoccoli in pvc pvc plinths



acciaio (opz.407)



di serie  
standard

## zoccoli in alluminio aluminium plinths

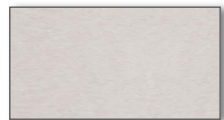

titanio verniciato  
(opz.414V)

## zoccoli in alluminio verniciati a polvere finitura opaca aluminum plinths height powder coated matt finish

### COLORI FREDDI OPACHI SOFT SOFT MATT COLD COLOURS



bianco assoluto (opz.740S)

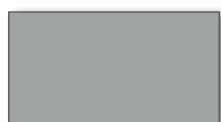

grigio traffico (opz.9511)



silver dark (opz.9507)



nero (opz.7892)

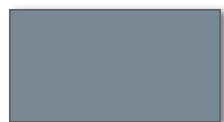

azzurro nube (opz.8379)

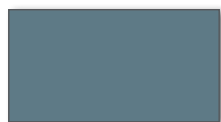

azzurro ottanio (opz.8385)

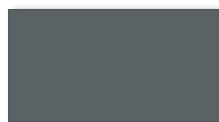

grigio bromo (opz.9533)

### COLORI CALDI OPACHI SOFT SOFT MATT HOT COLOURS



lino (opz.9513)

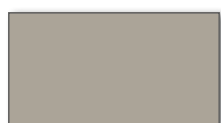

grigio kenya (opz.9501)

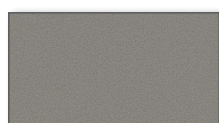

grigio selce (opz.SE)

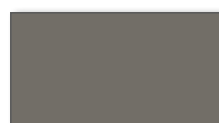

grigio piombo (opz.9537)

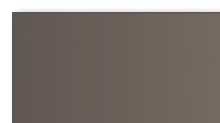

terra d'ombra (opz.955T)

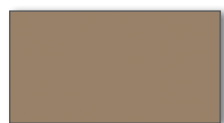

ottone (opz.7761)



umber (opz.955U)



cuoio (opz.8887)



ghisa (opz.9509)



fumo (opz.9531)



giallo digione (opz.8257)

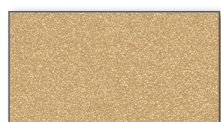

oro (opz.AU)

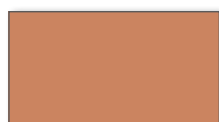

cotto (opz.8887)



rame (opz.8167)

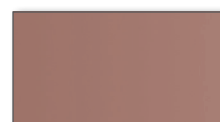

rame brunito (opz.8168)



rosso persia (opz.8165)

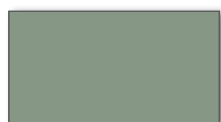

verde celadon (opz.8485)



rosso velvet (opz.8169)

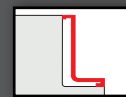

# Neck

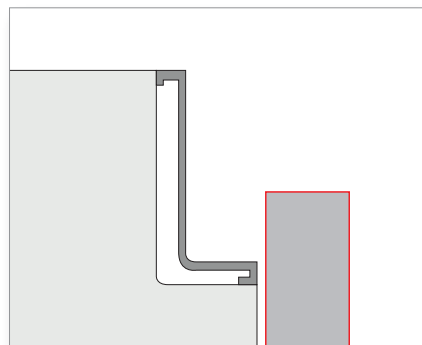

## ANTA SQUADRATA SENZA PROFILO

SQUARED DOOR WITHOUT  
PROFILE

# Lux

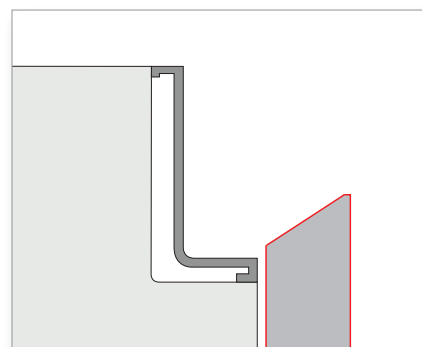

## ANTA INCLINATA SENZA PROFILO

DOOR WITHOUT INCLINED  
PROFILE

### FINITURE PROFILI E GOLE SPAZZOLATI FINGER RAILS AND PROFILES BRUSHED FINISHES

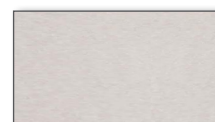

titanio verniciato  
(opz.414V)

### FINITURE PROFILI E GOLE VERNICIATI A POLVERE OPACHI MATT FINGER RAILS AND PROFILES POWDER COATED FINISHES

#### COLORI FREDDI OPACHI SOFT SOFT MATT COLD COLOURS



bianco assoluto (opz.740S)



grigio traffico (opz.9511)

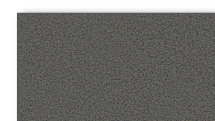

silver dark (opz.9507)



nero (opz.7892)



azzurro nube (opz.8379)



azzurro ottanio (opz.8385)



grigio bromo (opz.9533)

#### COLORI CALDI OPACHI SOFT SOFT MATT HOT COLOURS



lino (opz.9513)

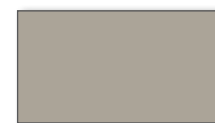

grigio kenya (opz.9501)

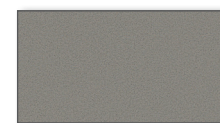

grigio selce (opz.SE)

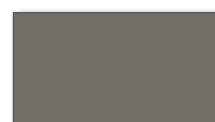

grigio piombo (opz.9537)



terra d'ombra (opz.955T)



umber (opz.955U)



ottone (opz.7761)



cuoio (opz.8897)



ghisa (opz.9509)



fumo (opz.9531)



giallo digione (opz.8257)



oro (opz.AU)



cotto (opz.8887)



rame (opz.8167)

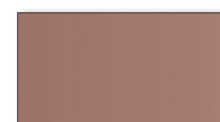

rame brunito (opz.8168)

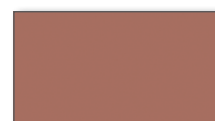

rosso persia (opz.8165)

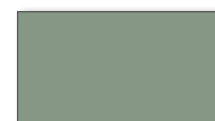

verde celadon (opz.8485)



rosso velvet (opz.8169)

# Bridge

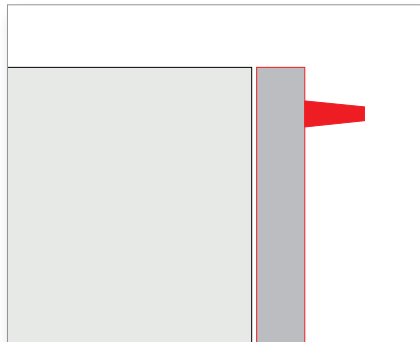







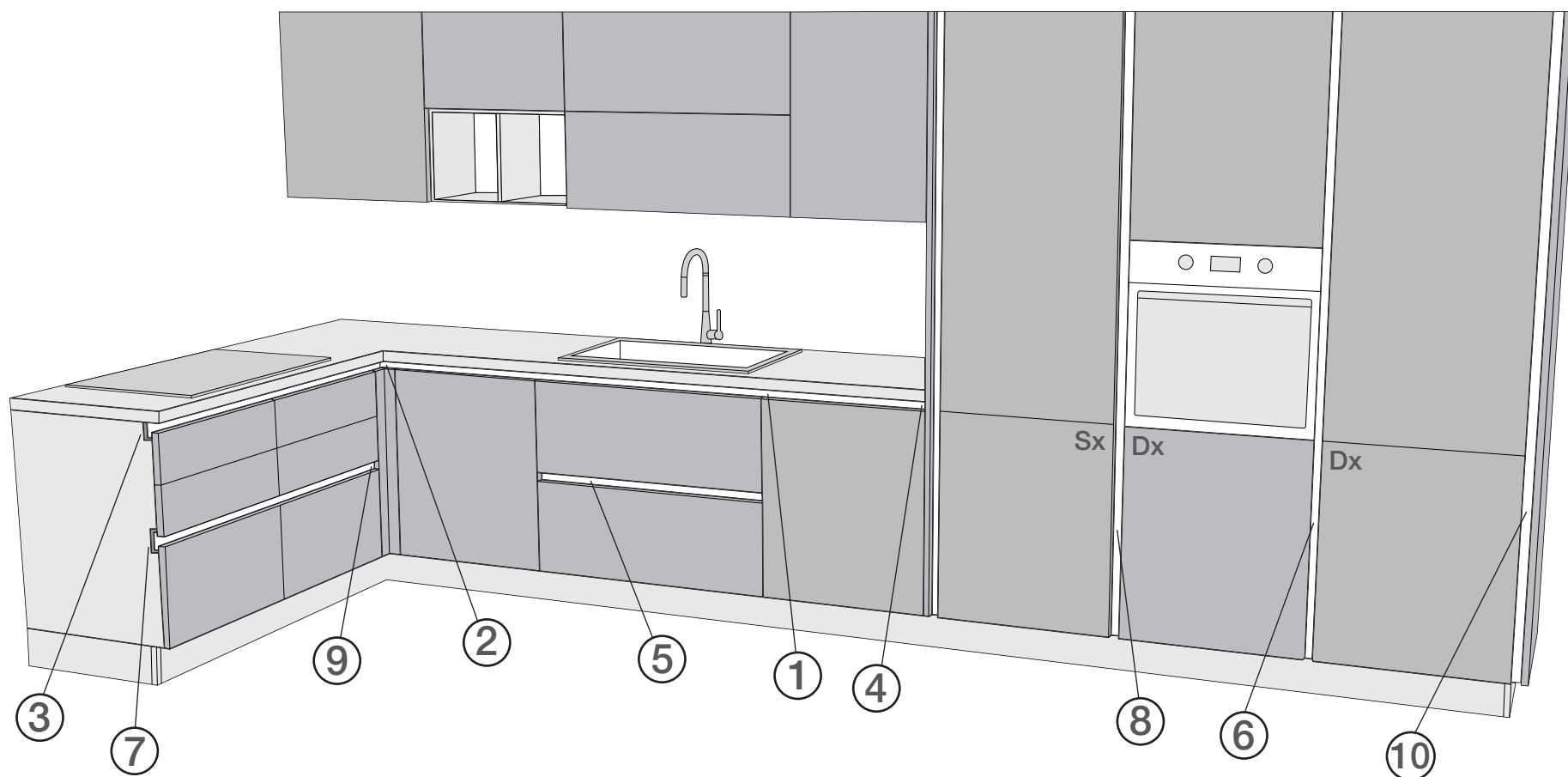
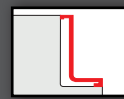

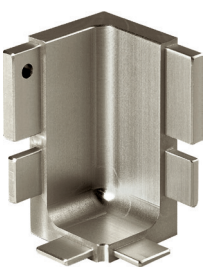
**ANTA CON MANIGLIA  
FRONTALE**  
DOOR WITH FRONT HANDLE

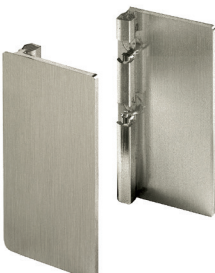

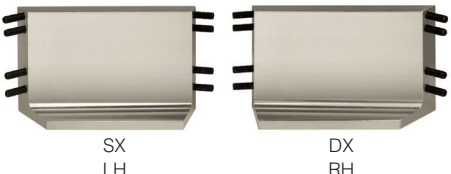
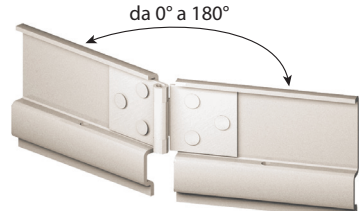

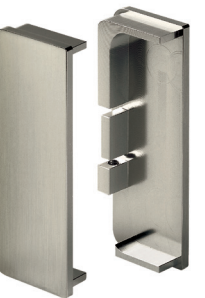

	COD.		COD.
<p><b>1</b></p> <p><b>Gola sottotop tipo "A"</b> Costo gola già compreso nel prezzo delle basi Type "A" undermount finger rail Finger rail cost already included in base unit price</p>  <p style="text-align: right;">al ml per lm</p>	G950010	<p><b>2</b></p> <p><b>Angolo interno a 90° per gola tipo "A"</b> Costo angolare già compreso nel prezzo delle basi angolo 90° interior corner for "A" type finger rail Corner piece cost already included in corner unit price</p>  <p style="text-align: right;">cadauno each</p>	G950050
<p><b>3</b></p> <p><b>Terminale aperto dx o sx per gola tipo "A" da utilizzare a fine composizione in presenza di fianco struttura non rifinito.</b> RH or LH open end for type "A" finger rail to be placed at the end of the composition in presence of unfinished structure side.</p>  <p style="text-align: right;"><b>terminale DX</b> RH end <b>terminale SX</b> LH end</p>	G950021 G950022	<p><b>4</b></p> <p><b>Terminale chiuso dx o sx per gola tipo "A" da utilizzare solo tra basi e colonne o a fine composizione in presenza di fianco struttura rifinito come anta senza scassi per gola.</b> RH or LH closure for type "A" finger rail to be placed only between base units and column or at the end of the composition in presence of structure side finished as a door without recess for finger rail.</p>  <p style="text-align: right;"><b>terminale DX</b> RH end <b>terminale SX</b> LH end</p>	G950031 G950032

	COD.			COD.	
<p><b>Coppia angolari per kit raccordo base angolo 110x110</b>  <b>Obbligatorii</b>            Couple corner piece for fitting kit corner base unit 110x110  <b>Obbligatori</b></p>  <p>SX LH      DX RH</p> <p><b>in alluminio</b> aluminium</p> <p><b>angolare DX</b> RH corner piece</p> <p><b>angolare SX</b> LH corner piece</p>				<p><b>2</b></p> <p><b>Angolare con snodo per unione fuori squadra per gola tipo "A"</b>            Corner piece with joint for out-of-plumb joining for type "A" finger rail</p>  <p>da 0° a 180°</p>	
	G950058				
	G950059				
				G950060	
<p><b>5</b></p> <p><b>Gola intermedia tipo "B"</b>  <b>Costo gola già compreso nel prezzo delle basi con cassetti o cestoni</b>            Type "B" intermediate finger rail            Finger rail cost already included in price base unit with drawers or deep drawers</p>  <p><b>al ml</b> per lm</p>				<p><b>6</b></p> <p><b>Mezza gola verticale tipo "C" (completa di distanziale)</b>            Type "C" half vertical finger rail (complete with spacer)</p>  <p>sezione mezza gola tipo "C" cross section of type "C" finger rail</p> <p>Piedi H 13 H 96 H 132 H 204 H 228</p> <p>Piedi H 6 H 108 H 144 H 216</p>	
	G950110			G950310	
				G950330	
				G950350	
				G950370	
				G950320	
				G950340	
				G950360	
<p><b>7</b></p> <p><b>Terminale aperto dx o sx per gola tipo "B" da utilizzare a fine composizione in presenza di fianco struttura non rifinito.</b>            RH or LH open end for type "B" finger rail to be placed at the end of the composition in presence of unfinished structure side.</p>  <p><b>terminale DX</b> RH end</p> <p><b>terminale SX</b> LH end</p>				<p><b>8</b></p> <p><b>Gola verticale intermedia tipo "D" (completa di distanziale)</b>            Type "D" intermediate vertical finger rail (complete with spacer)</p>  <p>sezione gola tipo "D" cross section of type "D" finger rail</p> <p>Piedi H 13 H 96 H 132 H 204 H 228</p> <p>Piedi H 6 H 108 H 144 H 216</p>	
	G950121			G950410	
	G950122			G950430	
				G950450	
				G950470	
				G950420	
				G950440	
				G950460	
<p><b>9</b></p> <p><b>Terminale chiuso dx o sx per gola tipo "B" da utilizzare solo tra cassettiere e lavastoviglie/colonne o a fine composizione in presenza di fianco struttura rifinito come anta senza scassi per gola.</b>            RH or LH closure for type "B" finger rail to be placed only between drawer units and dishwasher/columns or at the end of the composition in presence of structure side finished as a door without recess for finger rail.</p>  <p><b>terminale DX</b> RH end</p> <p><b>terminale SX</b> LH end</p>				<p><b>10</b></p> <p><b>Gola verticale laterale tipo "E" (completa di distanziale)</b>            Type "E" lateral vertical finger rail (complete with spacer)</p>  <p>sezione gola tipo "E" cross section of type "E" finger rail</p> <p>Piedi H 13 H 96 H 132 H 204 H 228</p> <p>Piedi H 6 H 108 H 144 H 216</p>	
	G950131			G950510	
	G950132			G950530	
				G950550	
				G950570	
				G950520	
				G950540	
				G950560	

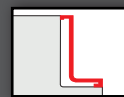

**VISTA FRONTALE E LATERALE ZOCCOLO H 13 PER BASI H 88**

FRONT AND SIDE VIEW PLINTH H 13 FOR BASE UNITS H 88

**PROSPETTO LATERALE**

Fianco struttura come anta  
senza scasso per gola

**SIDE VIEW**

Structural side as door without  
recess for finger rail

**PROSPETTO LATERALE**

Fianco struttura con scassi per gola

**SIDE VIEW**

Structural side with recess for finger rail

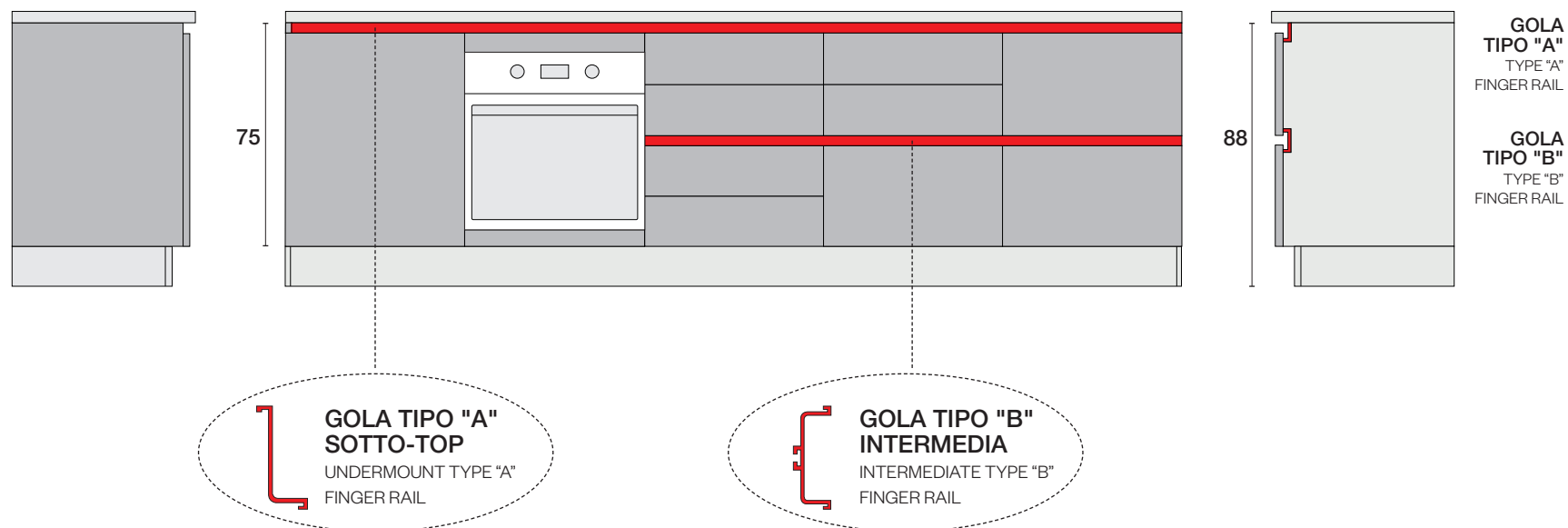

**VISTA FRONTALE E LATERALE ZOCCOLO H 6 PER BASI H 90**

FRONT AND SIDE VIEW PLINTH H 6 FOR BASE UNITS H 90

**PROSPETTO LATERALE**

Fianco struttura come anta  
senza scasso per gola

**SIDE VIEW**

Structural side as door without  
recess for finger rail

**PROSPETTO LATERALE**

Fianco struttura con scassi per gola

**SIDE VIEW**

Structural side with recess for finger rail

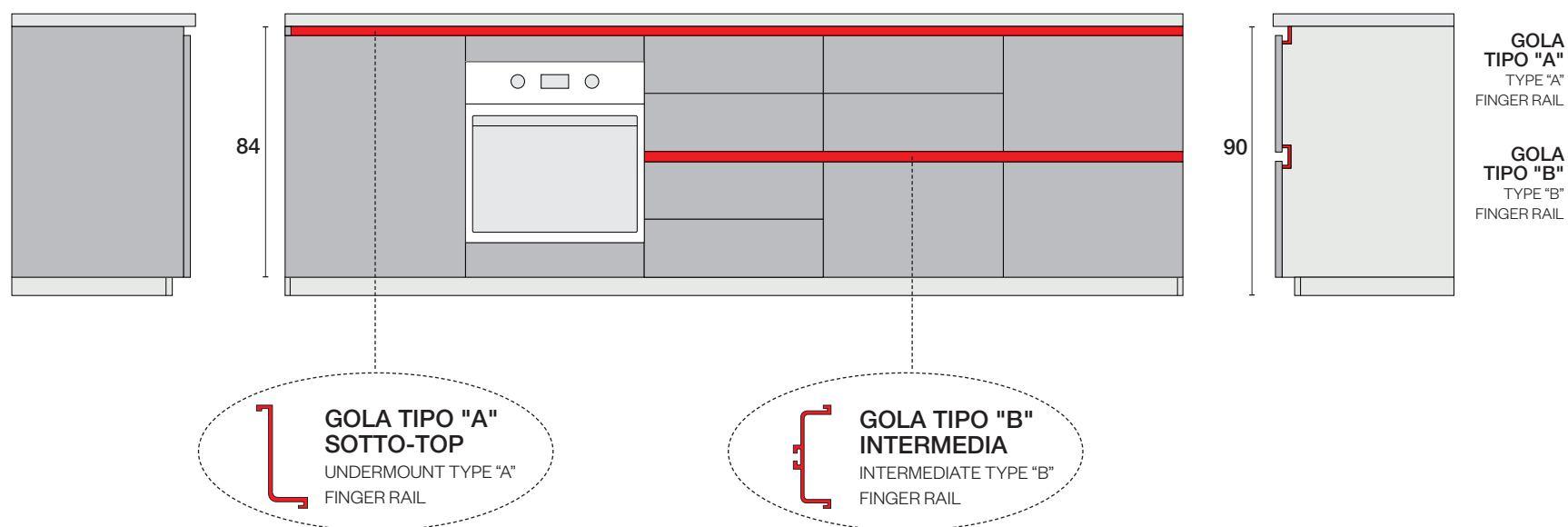



## VISTA FRONTALE ZOCCOLO H 13

FRONT VIEW PLINTH H 13

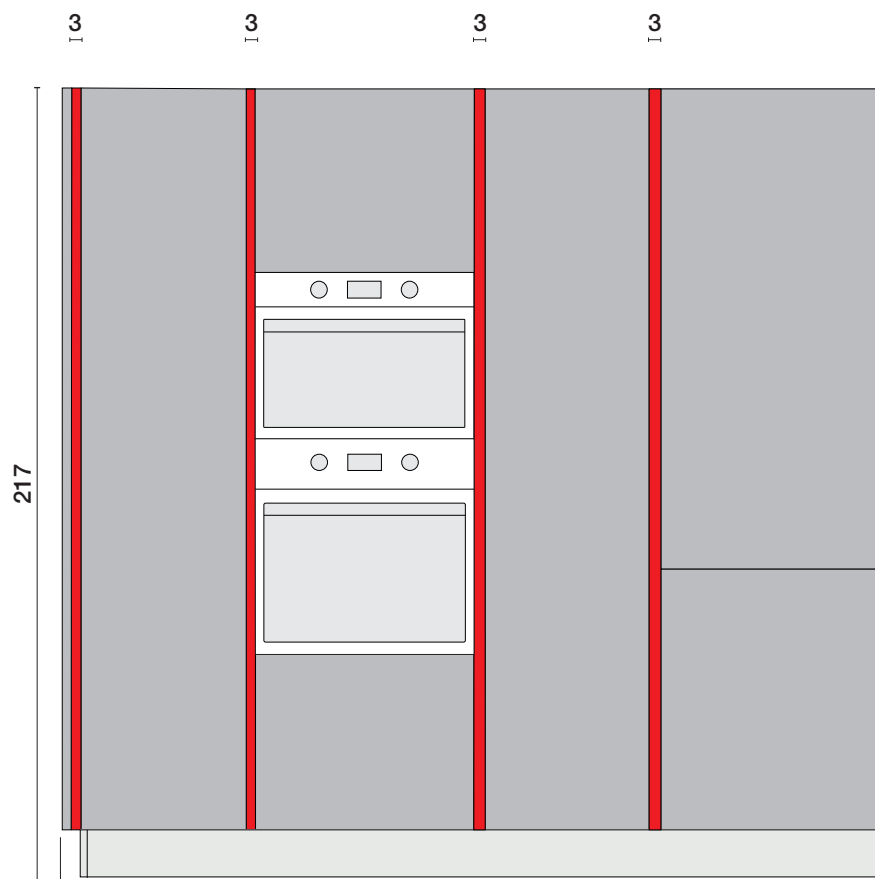

FIANCO RIPORTATO  
COME ANTA SP. 22 MM  
ADDITIONAL SIDE PANEL  
AS DOOR TH. 22 MM

**!** PER LA VERSIONE LUX SULLE COLONNE  
IL PROFILO ANTA È SEMPRE VERTICALE  
DOOR PROFILE ON THE COLUMNS FOR  
LUX VERSION IS ALWAYS VERTICAL

## VISTA FRONTALE ZOCCOLO H 6

FRONT VIEW PLINTH H 6

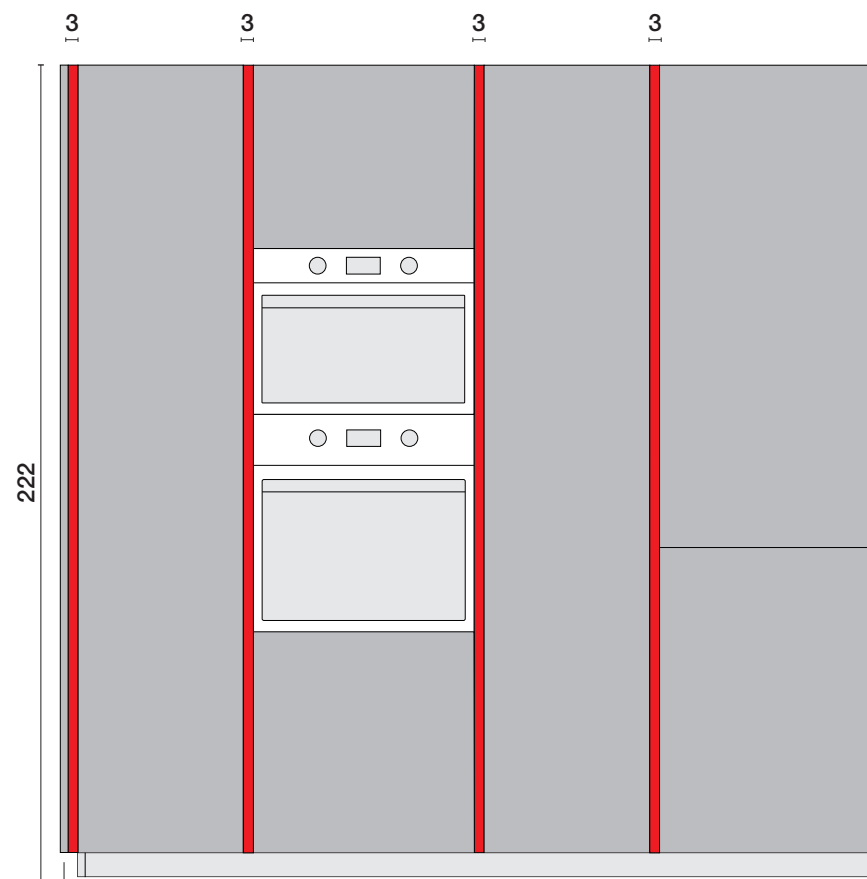

FIANCO RIPORTATO  
COME ANTA SP. 22 MM  
ADDITIONAL SIDE PANEL  
AS DOOR TH. 22 MM

**!** PER LA VERSIONE LUX SULLE COLONNE  
IL PROFILO ANTA È SEMPRE VERTICALE  
DOOR PROFILE ON THE COLUMNS FOR  
LUX VERSION IS ALWAYS VERTICAL

## VISTA DALL'ALTO

TOP VIEW

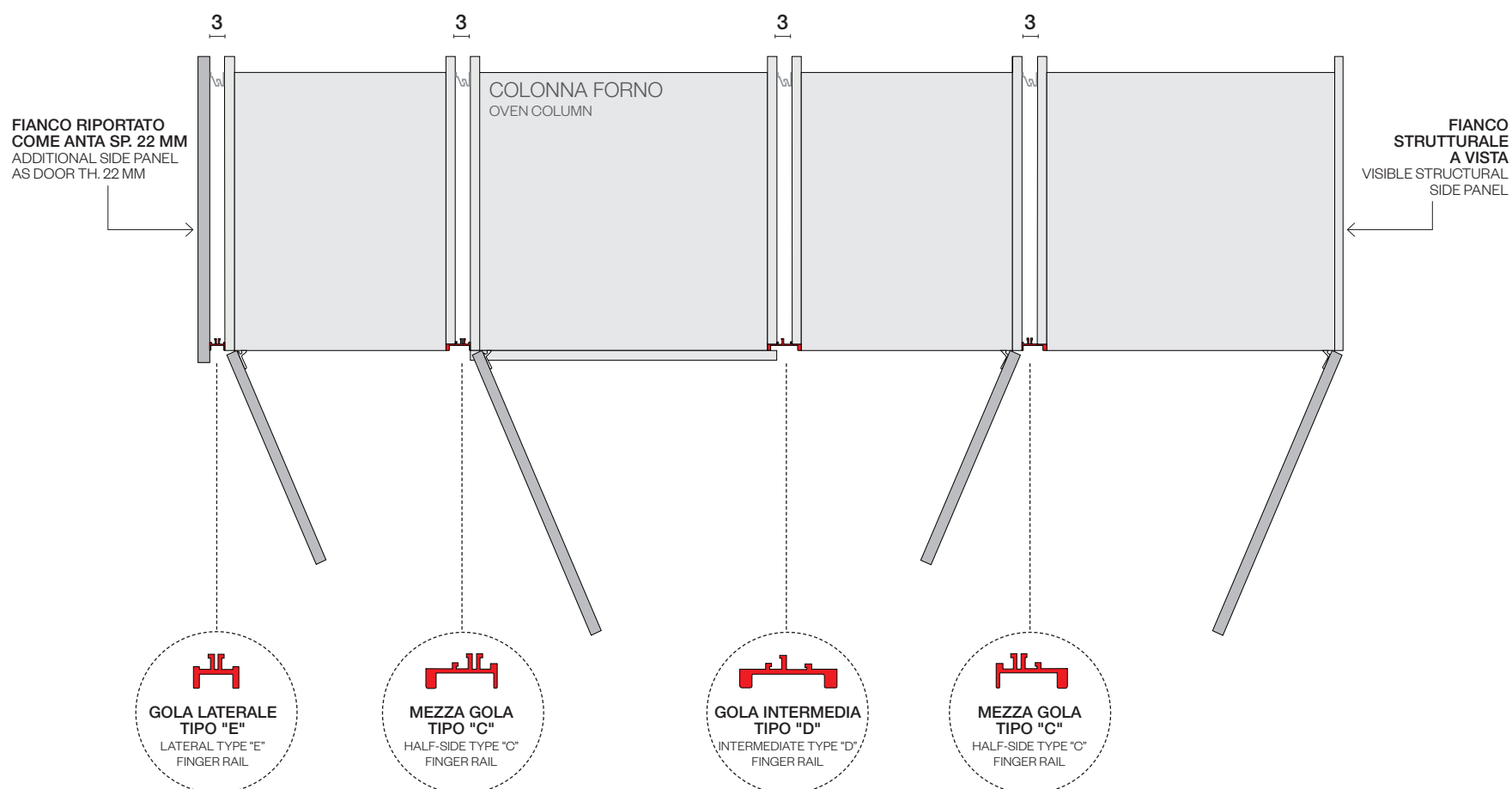

GOLA LATERALE  
TIPO "E"  
LATERAL TYPE "E"  
FINGER RAIL

MEZZA GOLA  
TIPO "C"  
HALF-SIDE TYPE "C"  
FINGER RAIL

GOLA INTERMEDIA  
TIPO "D"  
INTERMEDIATE TYPE "D"  
FINGER RAIL

MEZZA GOLA  
TIPO "C"  
HALF-SIDE TYPE "C"  
FINGER RAIL

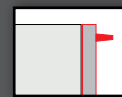

## DI SERIE STANDARD



Maniglia 547 finitura nichel satinato  
 anta L 15 → passo 64 mm  
 anta da L 30 a L 60 → passo 160 mm  
 anta da L 75 a L 90 → passo 320 mm

Handle 547 with satin nickel finish  
 door W 15 → centre-to-centre distance 64 mm  
 door from W 30 to W 60 → centre-to-centre distance 160 mm  
 door from W 75 to W 90 → centre-to-centre distance 320 mm



Maniglia 351B finitura dark brown  
 anta L 15 → passo 96 mm  
 anta L 30 a L 45 → passo 160 mm  
 anta da L 60 a L 120 → passo 320 mm

Handle 351B brown dark finish  
 door W 15 → centre-to-centre distance 96 mm  
 door W 30 to W 45 → centre-to-centre distance 160 mm  
 door from W 60 to W 120 → centre-to-centre distance 320 mm

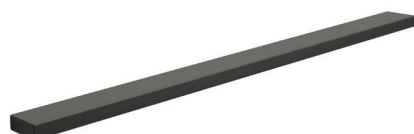

Maniglia 59S finitura anodizzato silver dark  
 anta L 15 → passo 32 mm  
 anta L 30 a L 45 → passo 160 mm  
 anta da L 60 a L 120 → passo 448 mm

Handle 59S oxidized dark silver finish  
 door W 15 → centre-to-centre distance 32 mm  
 door W 30 to W 45 → centre-to-centre distance 160 mm  
 door from W 60 to W 120 → centre-to-centre distance 448 mm

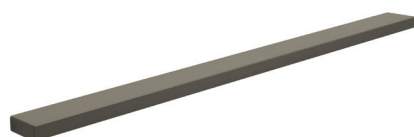

Maniglia 59BB finitura anodizzato titanio  
 anta L 15 → passo 32 mm  
 anta L 30 a L 45 → passo 160 mm  
 anta da L 60 a L 120 → passo 448 mm

Handle 59BB oxidized titanium finish  
 door W 15 → centre-to-centre distance 32 mm  
 door W 30 to W 45 → centre-to-centre distance 160 mm  
 door from W 60 to W 120 → centre-to-centre distance 448 mm

## A RICHIESTA ON REQUEST

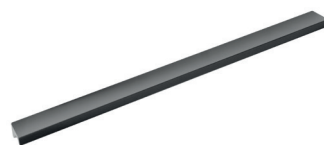

Maniglia K57 finitura verniciato brunito  
 anta L 15 → passo 64 mm  
 anta da L 30 a L 60 → passo 160 mm  
 anta da L 75 a L 90 → passo 320 mm

Handle K57 with burnished painted finish  
 door W 15 → centre-to-centre distance 64 mm  
 door from W 30 to W 60 → centre-to-centre distance 160 mm  
 door from W 75 to W 90 → centre-to-centre distance 320 mm



Maniglia 351R finitura rame brunito  
 anta L 15 → passo 96 mm  
 anta L 30 a L 45 → passo 160 mm  
 anta da L 60 a L 120 → passo 320 mm

Handle 351R burnished copper finish  
 door W 15 → centre-to-centre distance 96 mm  
 door W 30 to W 45 → centre-to-centre distance 160 mm  
 door from W 60 to W 120 → centre-to-centre distance 320 mm

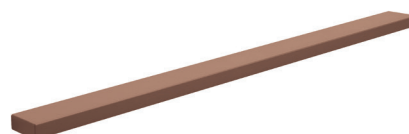

Maniglia 59RA finitura anodizzato rame anticato  
 anta L 15 → passo 32 mm  
 anta L 30 a L 45 → passo 160 mm  
 anta da L 60 a L 120 → passo 448 mm

Handle 59RA oxidized antiqued copper finish  
 door W 15 → centre-to-centre distance 32 mm  
 door W 30 to W 45 → centre-to-centre distance 160 mm  
 door from W 60 to W 120 → centre-to-centre distance 448 mm



Maniglia 59N finitura anodizzato nero  
 anta L 15 → passo 32 mm  
 anta L 30 a L 45 → passo 160 mm  
 anta da L 60 a L 120 → passo 448 mm

Handle 59N oxidized black finish  
 door W 15 → centre-to-centre distance 32 mm  
 door W 30 to W 45 → centre-to-centre distance 160 mm  
 door from W 60 to W 120 → centre-to-centre distance 448 mm



Maniglia 351S finitura silver dark  
 anta L 15 → passo 96 mm  
 anta L 30 a L 45 → passo 160 mm  
 anta da L 60 a L 120 → passo 320 mm

Handle 351S silver dark finish  
 door W 15 → centre-to-centre distance 96 mm  
 door W 30 to W 45 → centre-to-centre distance 160 mm  
 door from W 60 to W 120 → centre-to-centre distance 320 mm



Maniglia 351T finitura titanio  
 anta L 15 → passo 96 mm  
 anta L 30 a L 45 → passo 160 mm  
 anta da L 60 a L 120 → passo 320 mm

Handle 351T titanium finish  
 door W 15 → centre-to-centre distance 96 mm  
 door W 30 to W 45 → centre-to-centre distance 160 mm  
 door from W 60 to W 120 → centre-to-centre distance 320 mm

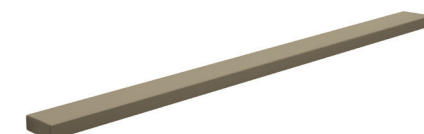

Maniglia 59BA finitura anodizzato bronzo anticato  
 anta L 15 → passo 32 mm  
 anta L 30 a L 45 → passo 160 mm  
 anta da L 60 a L 120 → passo 448 mm

Handle 59BA oxidized antiqued bronze finish  
 door W 15 → centre-to-centre distance 32 mm  
 door W 30 to W 45 → centre-to-centre distance 160 mm  
 door from W 60 to W 120 → centre-to-centre distance 448 mm



Maniglia 59G finitura ghisa  
 anta L 15 → passo 32 mm  
 anta L 30 a L 45 → passo 160 mm  
 anta da L 60 a L 120 → passo 448 mm

Handle 59G cast iron finish  
 door W 15 → centre-to-centre distance 32 mm  
 door W 30 to W 45 → centre-to-centre distance 160 mm  
 door from W 60 to W 120 → centre-to-centre distance 448 mm

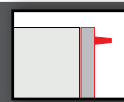

**A RICHIESTA ON REQUEST**



Maniglia 352G finitura oro  
anta L 15 → pomo  
anta L 30 a L 45 → passo 160 mm  
anta da L 60 a L 120 → passo 320 mm

Handle 352G gold finish  
door W 15 → knob  
door W 30 to W 45 → centre-to-centre distance 160 mm  
door from W 60 to W 120 → centre-to-centre distance 320 mm



Maniglia 352R finitura rame  
anta L 15 → pomo  
anta L 30 a L 45 → passo 160 mm  
anta da L 60 a L 90 → passo 320 mm

Handle 352R copper finish  
door W 15 → knob  
door W 30 to W 45 → centre-to-centre distance 160 mm  
door from W 60 to W 90 → centre-to-centre distance 320 mm

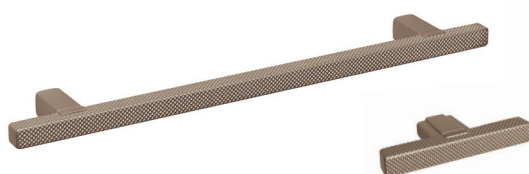

Maniglia 57BA finitura bronzo anticato  
anta L 15 → passo 12 mm  
anta L 30 a L 45 → passo 160 mm  
anta da L 60 a L 90 → passo 320 mm

Handle 57BA antiqued bronze finish  
door W 15 → centre-to-centre distance 12 mm  
door W 30 to W 45 → centre-to-centre distance 160 mm  
door from W 60 to W 90 → centre-to-centre distance 320 mm

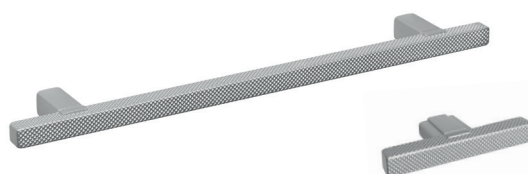

Maniglia 57K finitura acciaio  
anta L 15 → passo 12 mm  
anta L 30 a L 45 → passo 160 mm  
anta da L 60 a L 90 → passo 320 mm

Handle 57K steel finish  
door W 15 → centre-to-centre distance 12 mm  
door W 30 to W 45 → centre-to-centre distance 160 mm  
door from W 60 to W 90 → centre-to-centre distance 320 mm

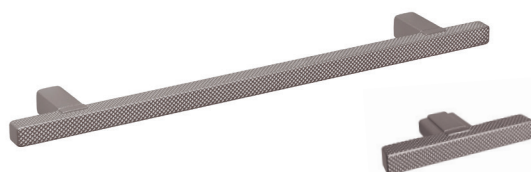

Maniglia 57BB finitura bronzo brunito  
anta L 15 → passo 12 mm  
anta L 30 a L 45 → passo 160 mm  
anta da L 60 a L 90 → passo 320 mm

Handle 57BB burnished bronze finish  
door W 15 → centre-to-centre distance 12 mm  
door W 30 to W 45 → centre-to-centre distance 160 mm  
door from W 60 to W 90 → centre-to-centre distance 320 mm

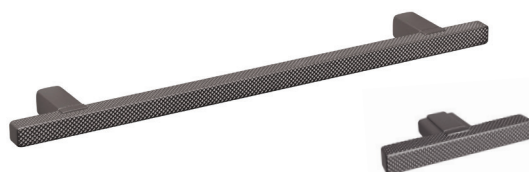

Maniglia 57F finitura grafite  
anta L 15 → passo 12 mm  
anta L 30 a L 45 → passo 160 mm  
anta da L 60 a L 90 → passo 320 mm

Handle 351B graphite finish  
door W 15 → centre-to-centre distance 12 mm  
door W 30 to W 45 → centre-to-centre distance 160 mm  
door from W 60 to W 90 → centre-to-centre distance 320 mm

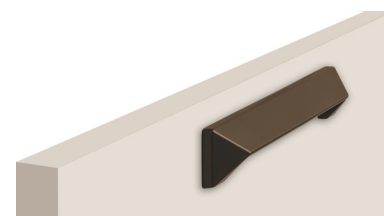

Maniglia K90 finitura bronzo  
anta da L 15 a L 30 → passo 64 mm  
anta da L 40 a L 120 → passo 160 mm

Handle K90 bronze finish  
door from W 15 to W 30 → centre-to-centre distance 64 mm  
door from W 40 to W 120 → centre-to-centre distance 160 mm



Maniglia K50 finitura cromo  
anta da L 30 a L 45 → passo 160 mm  
anta da L 60 a L 90 → passo 320 mm

Handle K50 chrome finish  
door from W 30 to W 45 → centre-to-centre distance 160 mm  
door from W 60 to W 90 → centre-to-centre distance 320 mm



Pomo 244P finitura cromo  
solo per anta L 15 in abbinamento  
alla maniglia K50

Knob 244P chrome finish  
only for door W 15 in combination  
to the handle K50

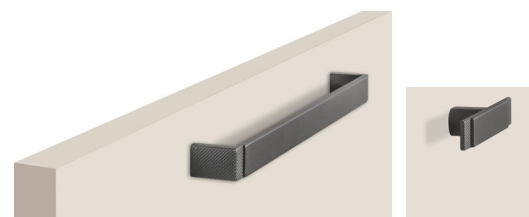

Maniglia K94 finitura silver dark  
anta da L 15 a L 30 → pomo  
anta da L 40 a L 65 → passo 160 mm  
anta da L 75 a L 120 → passo 320 mm

Handle K94 dark silver finish  
door from W 15 to W 30 → knob  
door from W 40 to W 65 → centre-to-centre distance 160 mm  
door from W 75 to W 120 → centre-to-centre distance 320 mm

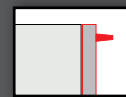

## MANIGLIA VERTICALE VERTICAL HANDLE

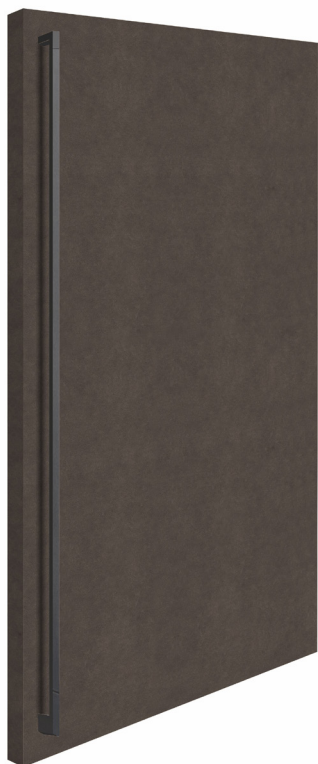

Maniglia M30NV finitura nero opaco  
passo in funzione dell'anta, vedi disegno tecnico  
Handle M30NV matt black finish  
centre-to-centre distance varies according to the door, see technical drawing

 La maniglia verticale non è disponibile per tutti gli elementi. Non inseribile su pensili, basi ed elementi fuori misura  
The vertical handle is not compatible with all the elements. Is not possible to insert it on the wall units, base units and oversized elements

MANIGLIA HANDLE	L. 39,7	passo 383 mm
MANIGLIA HANDLE	L. 51,7	passo 503 mm
MANIGLIA HANDLE	L. 63,7	passo 623 mm
MANIGLIA HANDLE	L. 75,7	passo 743 mm
MANIGLIA HANDLE	L. 123,7	passo 623/600 mm
MANIGLIA HANDLE	L. 135,7	passo 743/600 mm
MANIGLIA HANDLE	L. 195,7	passo 623/697/623 mm
MANIGLIA HANDLE	L. 207,7	passo 623/697/743 mm





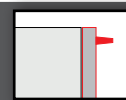

## MANIGLIA VERTICALE VERTICAL HANDLE



MANIGLIA HANDLE	L. 41,7	passo 383 mm
MANIGLIA HANDLE	L. 53,7	passo 503 mm
MANIGLIA HANDLE	L. 65,7	passo 623 mm
MANIGLIA HANDLE	L. 77,7	passo 743 mm
MANIGLIA HANDLE	L. 125,7	passo 623/600 mm
MANIGLIA HANDLE	L. 137,7	passo 743/600 mm
MANIGLIA HANDLE	L. 197,7	passo 623/697/623 mm
MANIGLIA HANDLE	L. 209,7	passo 623/697/743 mm

Maniglia M31KV finitura satinato spazzolato  
passo in funzione dell'anta, vedi disegno tecnico  
Handle M31KV satin brushed finish  
centre-to-centre distance varies according to the door, see technical drawing



MANIGLIA HANDLE	L. 41,7	passo 383 mm
MANIGLIA HANDLE	L. 53,7	passo 503 mm
MANIGLIA HANDLE	L. 65,7	passo 623 mm
MANIGLIA HANDLE	L. 77,7	passo 743 mm
MANIGLIA HANDLE	L. 125,7	passo 623/600 mm
MANIGLIA HANDLE	L. 137,7	passo 743/600 mm
MANIGLIA HANDLE	L. 197,7	passo 623/697/623 mm
MANIGLIA HANDLE	L. 209,7	passo 623/697/743 mm

Maniglia M32TV finitura titanio  
passo in funzione dell'anta, vedi disegno tecnico  
Handle M32TV titanium finish  
centre-to-centre distance varies according to the door, see technical drawing

 La maniglia verticale non è disponibile per tutti gli elementi. Non inseribile su pensili, basi ed elementi fuori misura.  
The vertical handle is not compatible with all the elements. Is not possible to insert it on the wall units, base units and oversized elements

# DISEGNO TECNICO MANIGLIE HANDLES TECHNICAL DRAWING

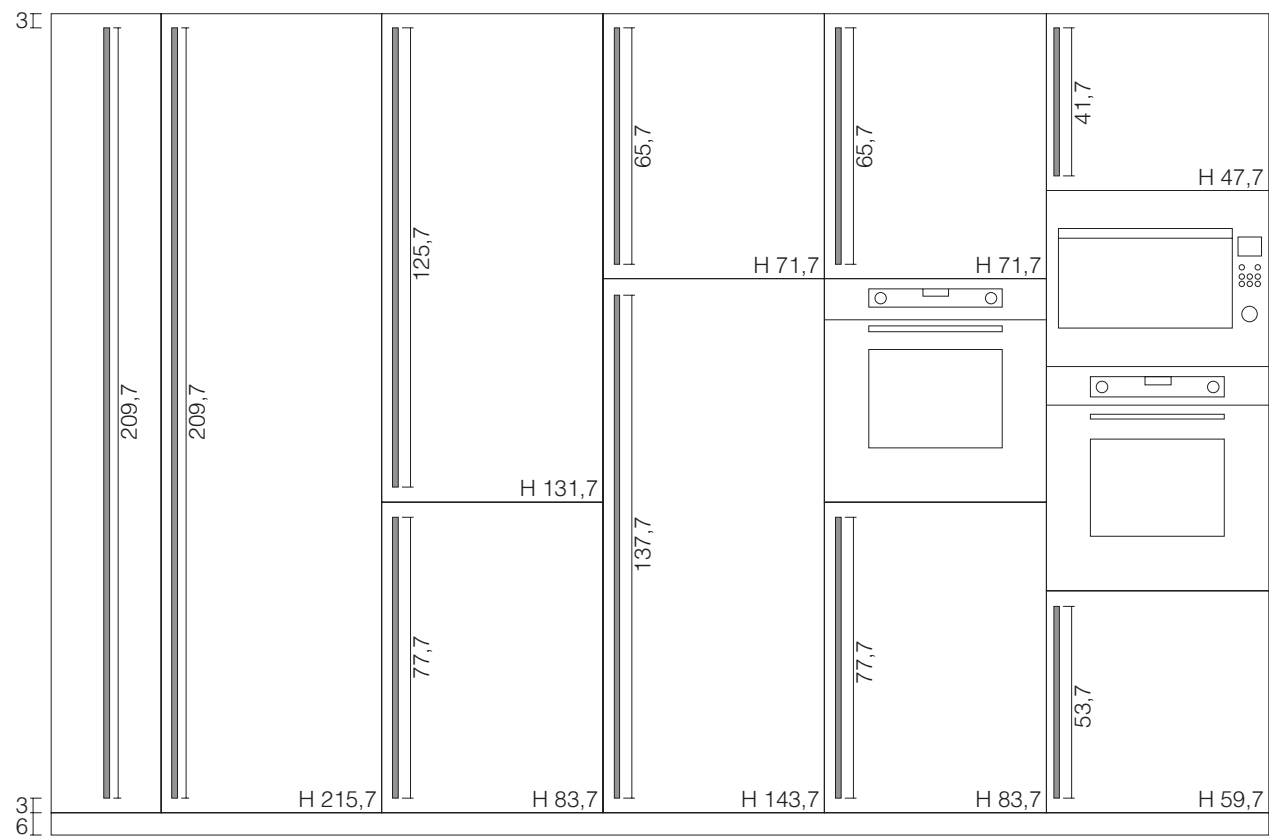
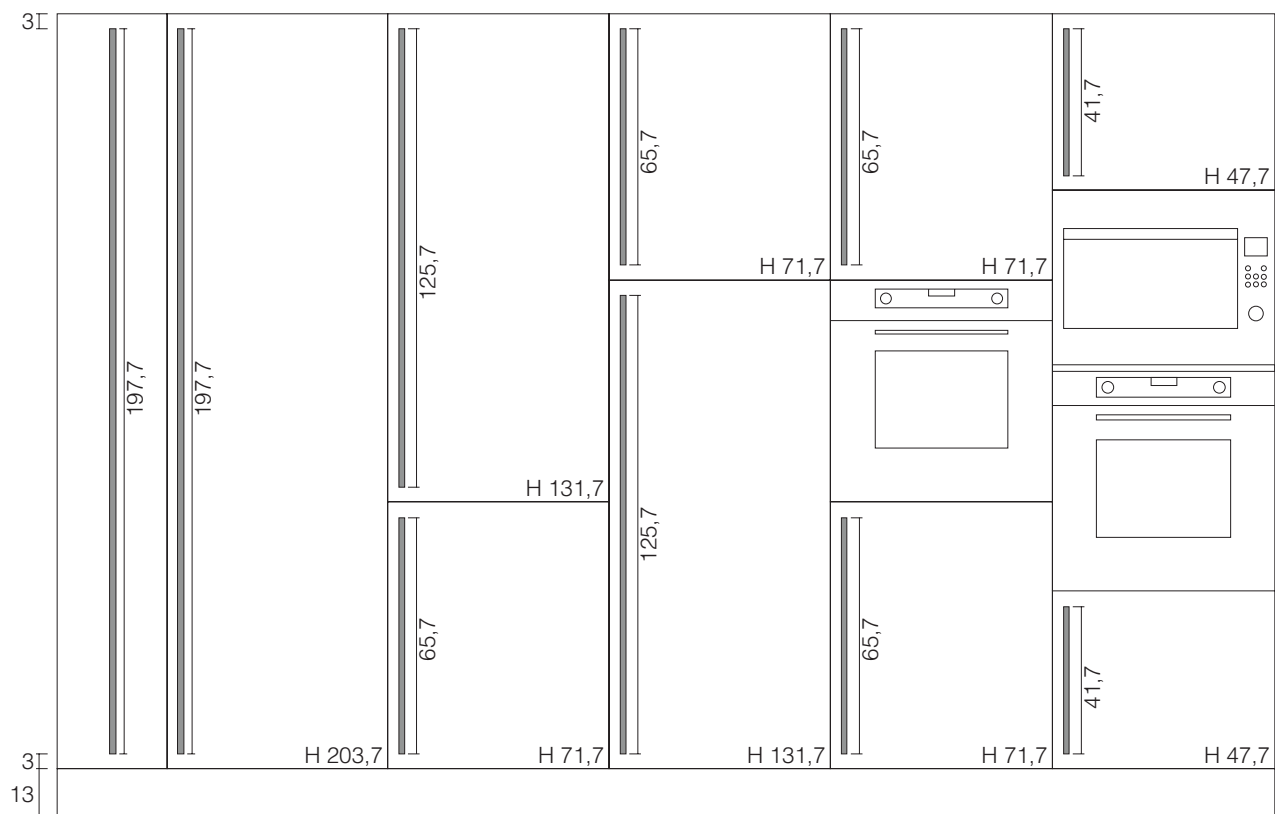

La maniglia verticale è disponibile anche per colonne con anta fino a terra, mantenendo lo stesso allineamento dall'alto riportato nei disegni tecnici.  
 The vertical handle is also available for columns with door down the ground while maintaining the same alignment from above shown in the technical drawings.



Maniglia M30NO finitura nero opaco  
passo in funzione dell'anta  
vedi disegno tecnico

Handle M30NO matt black finish  
centre-to-centre distance varies according  
to the door size see technical drawing

**DISEGNO TECNICO MANIGLIA** HANDLE TECHNICAL DRAWING

Angolo pensile a libro  
Book hanging corner

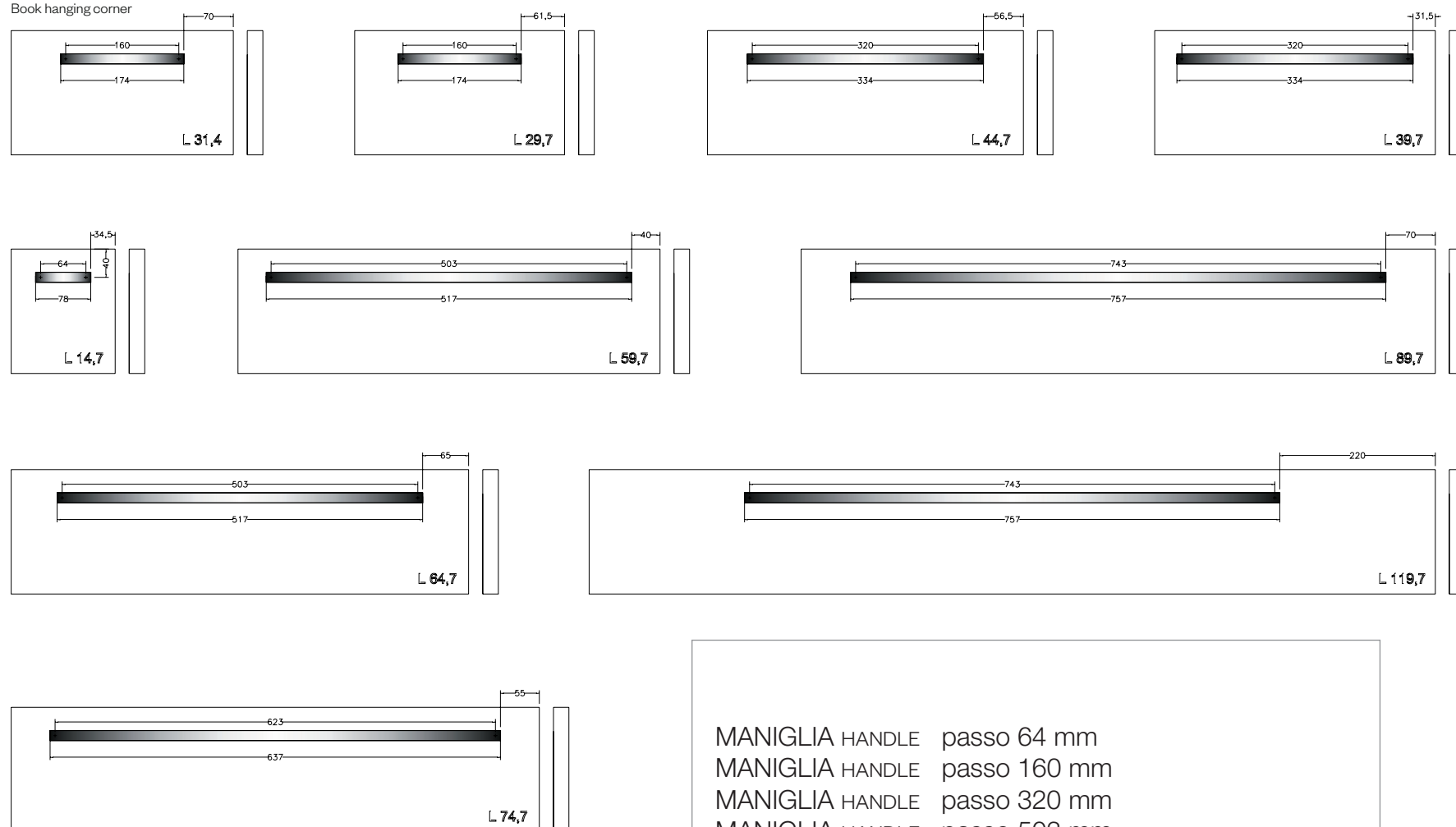

- MANIGLIA HANDLE passo 64 mm
- MANIGLIA HANDLE passo 160 mm
- MANIGLIA HANDLE passo 320 mm
- MANIGLIA HANDLE passo 503 mm
- MANIGLIA HANDLE passo 623 mm
- MANIGLIA HANDLE passo 743 mm



Maniglia M31KO finitura satinato spazzolato  
passo in funzione dell'anta  
vedi disegno tecnico

Handle M31KO satin brushed finish  
centre-to-centre distance varies according  
to the door size see technical drawing



Maniglia M32TO finitura titanio  
passo in funzione dell'anta  
vedi disegno tecnico

Handle M32TO titanium finish  
centre-to-centre distance varies according  
to the door size see technical drawing

**DISEGNO TECNICO MANIGLIA** HANDLE TECHNICAL DRAWING

Angolo pensile a libro  
Book hanging corner

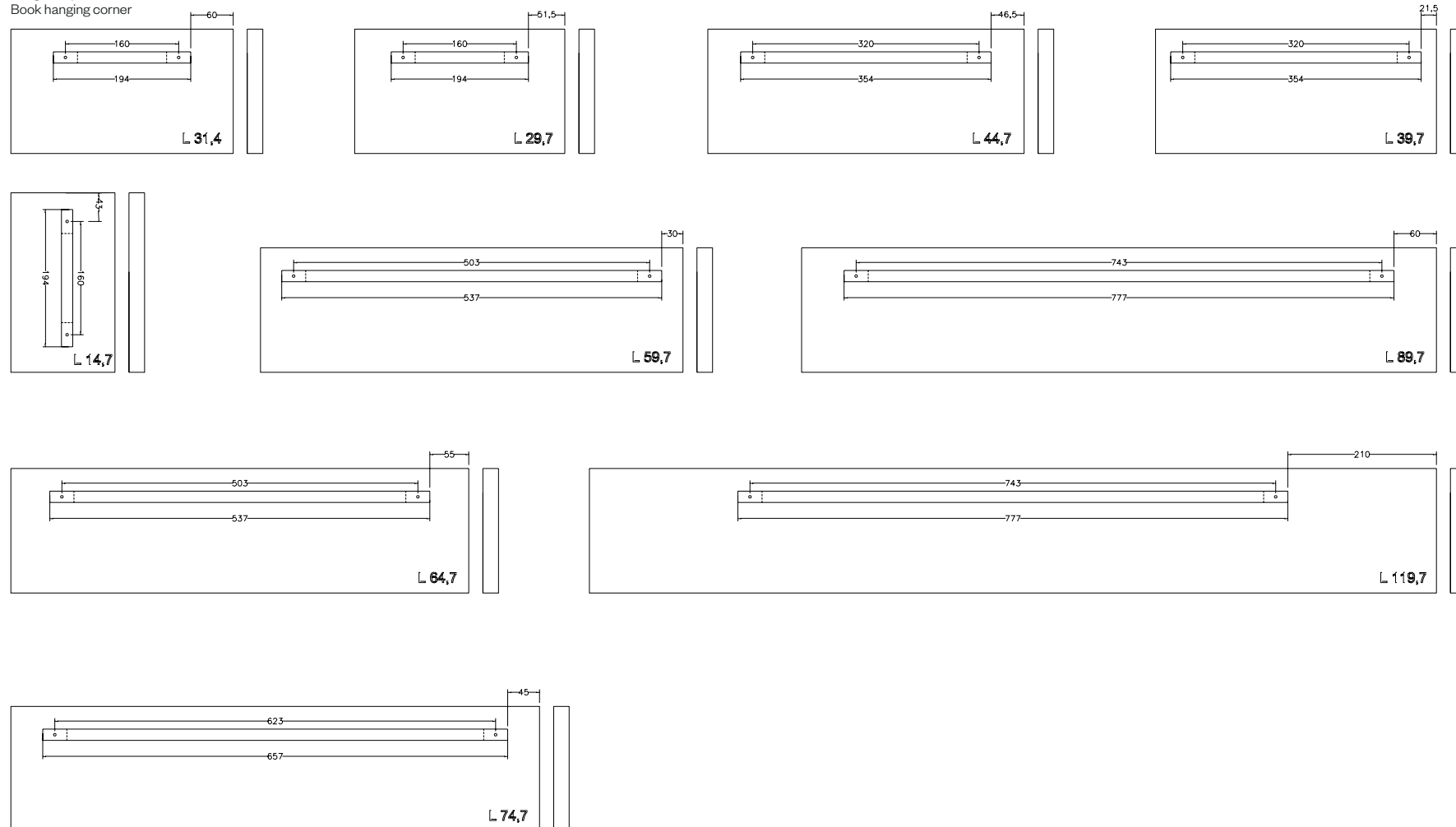

**MANIGLIA M31KO**

- MANIGLIA HANDLE passo 64 mm
- MANIGLIA HANDLE passo 160 mm
- MANIGLIA HANDLE passo 320 mm
- MANIGLIA HANDLE passo 503 mm
- MANIGLIA HANDLE passo 623 mm
- MANIGLIA HANDLE passo 743 mm

**MANIGLIA M32TO**

- MANIGLIA HANDLE passo 64 mm
- MANIGLIA HANDLE passo 160 mm
- MANIGLIA HANDLE passo 320 mm
- MANIGLIA HANDLE passo 503 mm
- MANIGLIA HANDLE passo 623 mm
- MANIGLIA HANDLE passo 743 mm

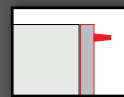

Maniglia "FLOW" costituito da un profilo integrato all'anta e una maniglia frontale a passo variabile. Le finiture disponibili sono: titanio, silver dark, umber, vedi disegno tecnico  
"FLOW" handle consisting of a profile integrated with the door and a front handle with variable pitch. Available finishes are: titanium, dark silver, umber, see technical drawing

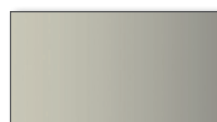

maniglia titanio  
opz.FLOWT

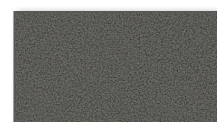

maniglia silver dark  
opz.FLOWS



maniglia umber  
opz.FLOWU

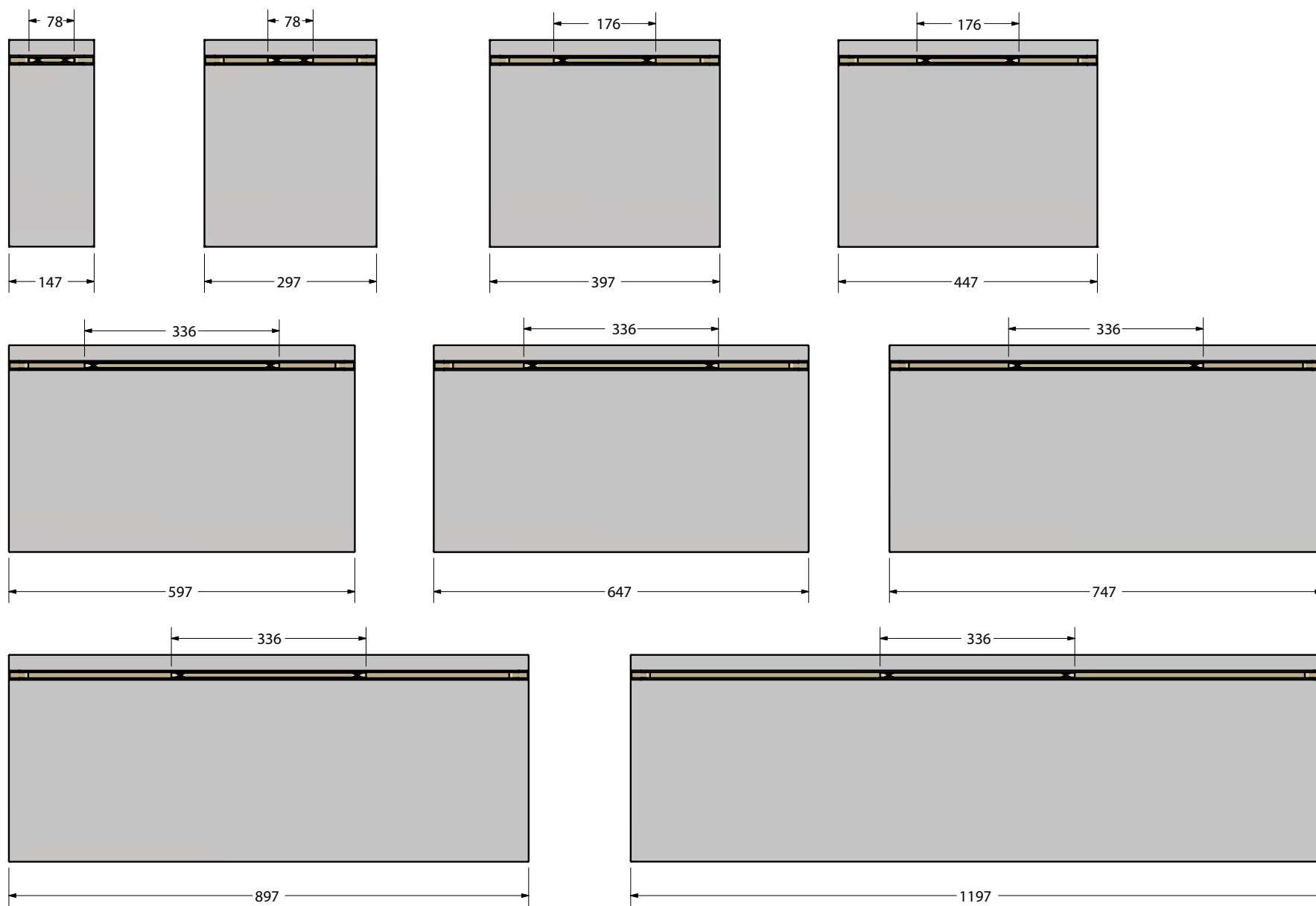

- ANTA DOOR L. 15
- ANTA DOOR L. 30
- ANTA DOOR L. 40
- ANTA DOOR L. 45
- ANTA DOOR L. 60
- ANTA DOOR L. 65
- ANTA DOOR L. 80
- ANTA DOOR L. 90
- ANTA DOOR L. 120



### PENSILI WALL UNITS

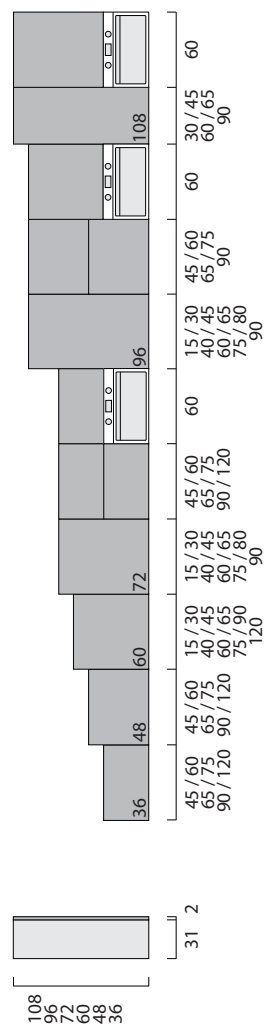

### BASI ZOCCOLO H.13 H.13 PLINTH BASE UNITS

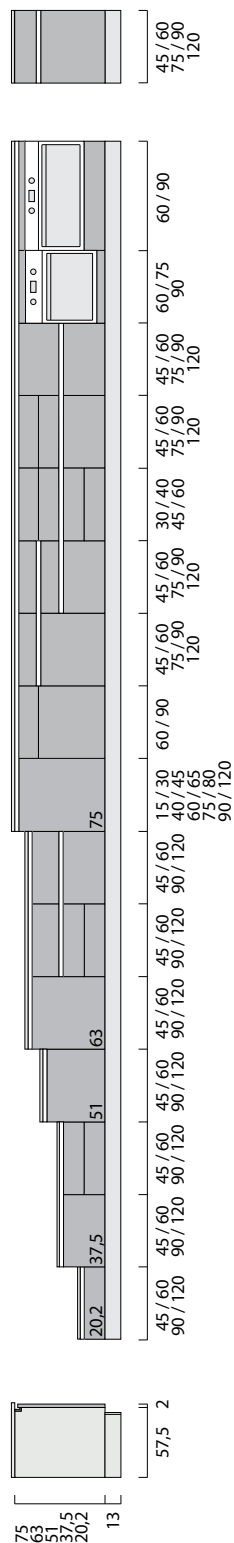

### BASI ZOCCOLO H.6 H.6 PLINTH BASE UNITS

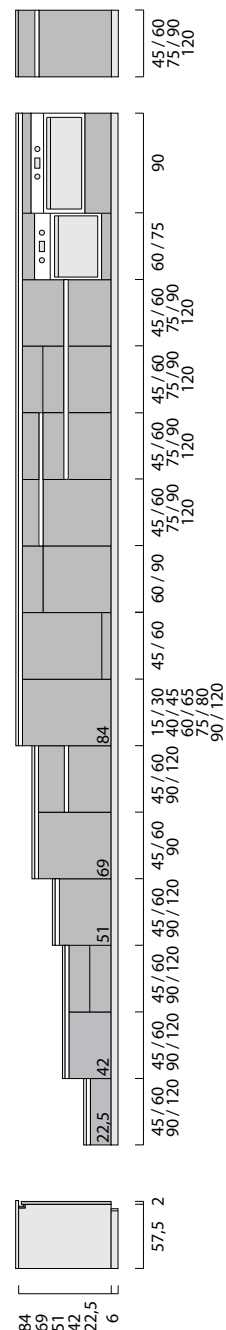

### BASI SOSPESE SUSPENDED BASE UNITS

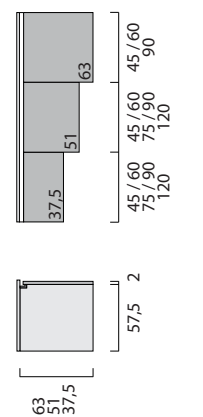

### BASI SOSPESE SUSPENDED BASE UNITS

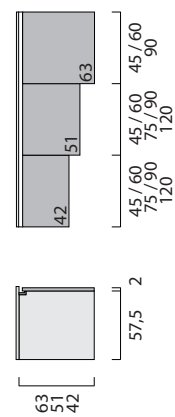

## COLONNE ZOCCOLO H.13

### H.13 PLINTH COLUMNS

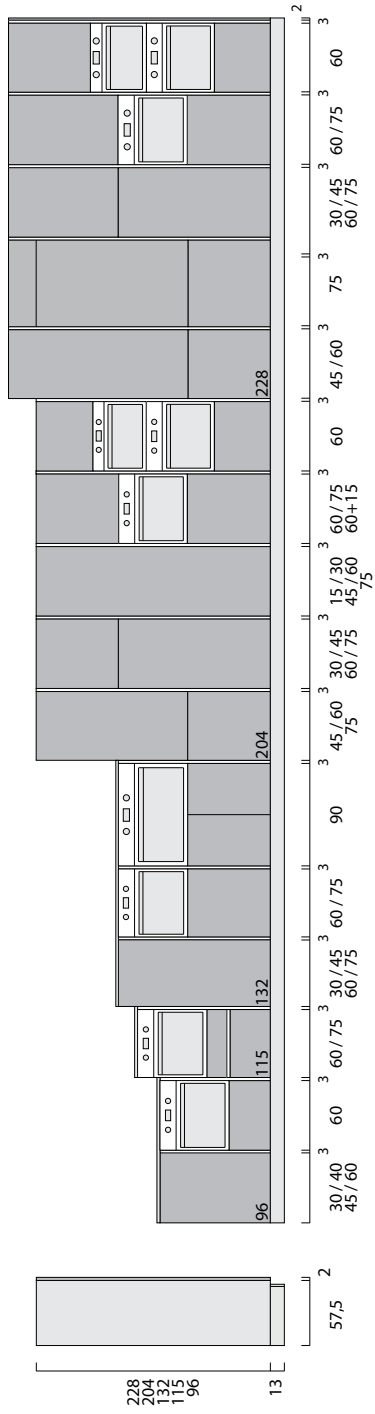

## COLONNE ZOCCOLO H.6

### H.6 PLINTH COLUMNS

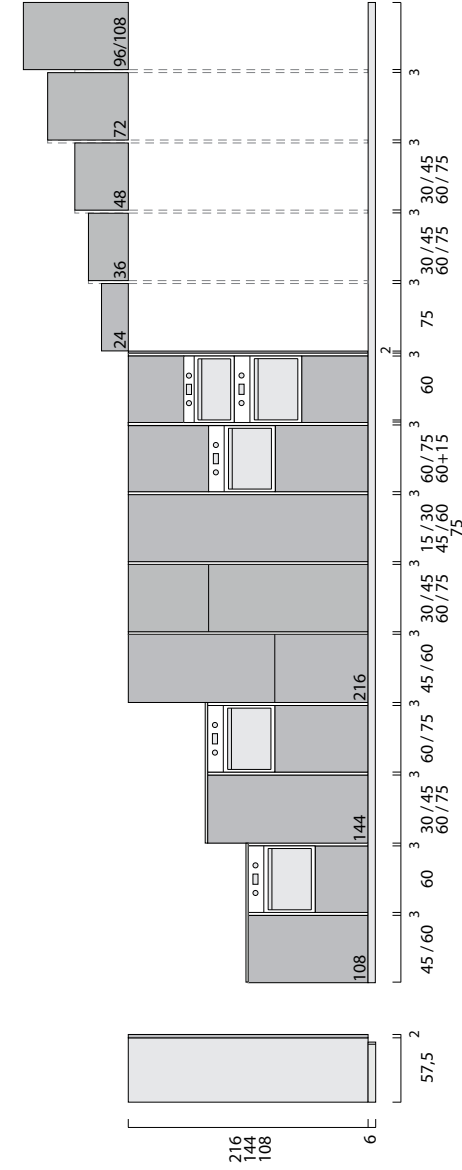

## ELEMENTI PER LIVING

### LIVING ELEMENTS

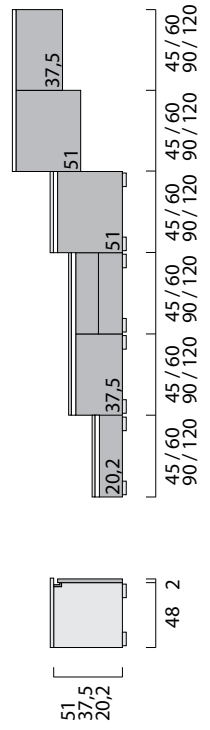

⚠ Elementi sopra colonna validi anche su colonne zoccolo H.13  
Above-column elements also valid on H.13 plinth columns

**i** COLONNE CON ANTE FINO A TERRA disponibili per piedi H.13 e piedi H.6. Per modistica disponibile con anta fino a terra vedere relativa sezione del listino.

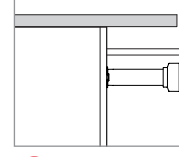

COLUMNS WITH DOOR DOWN TO GROUND available for H.13 feet and H.6 feet. For available elements with door down to ground see respective section in the price list.

⚠ Per attrezzature interne e meccanismi di apertura vedere relative sezioni nel listino.  
For internal equipment and opening mechanisms, see respective sections in the price list.

⚠ Per dimensioni dei singoli frontali vedere relative sezioni nel listino.  
For size of individual doors, see respective sections in the price list.





## PENSILI WALL UNITS

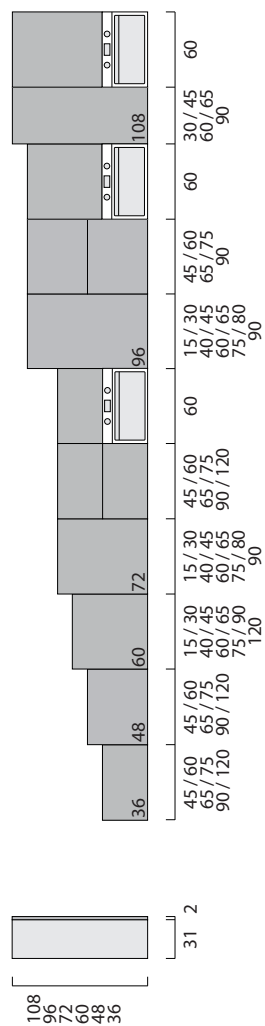

## BASI ZOCCOLO H.13 H.13 PLINTH BASE UNITS

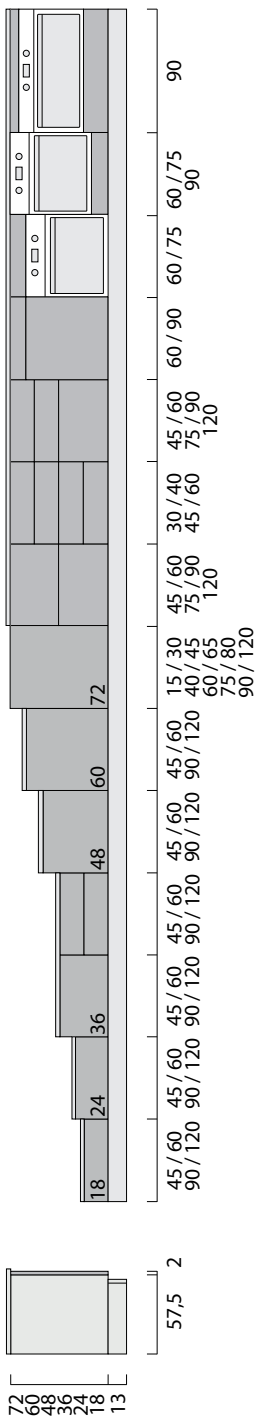

## BASI ZOCCOLO H.6 H.6 PLINTH BASE UNITS

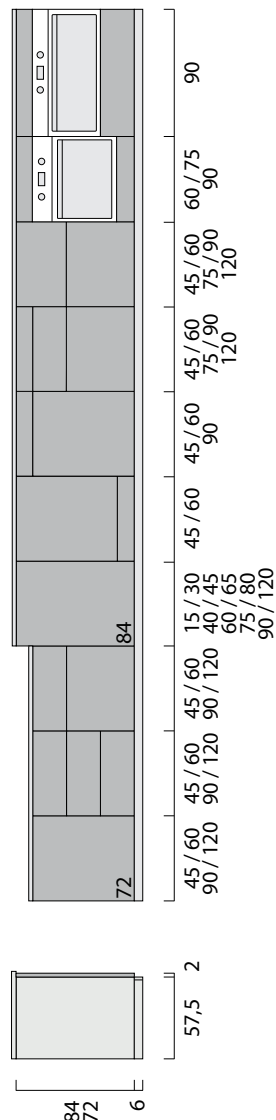

## BASI SOSPESE SUSPENDED BASE UNITS

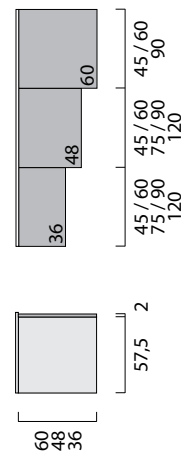



# LACCATO OPACO

MATT LACQUERED

Anta sp.20 mm costituita da un pannello in fibra di legno (mdf.E5 certificato FSC, conforme US PA TSCA Title VI e CARB ATCM P2) laccato opaco poliuretano fronte, retro e bordo finitura 20 gloss.  
20 mm thick door consisting of a wood fiber panel (FSC-certified mdf.E5, complying with US PA TSCA Title VI and CARB ATCM P2) polyurethane matte lacquer front, back and edge finish 20 gloss.

bianco assoluto (opz.740S)

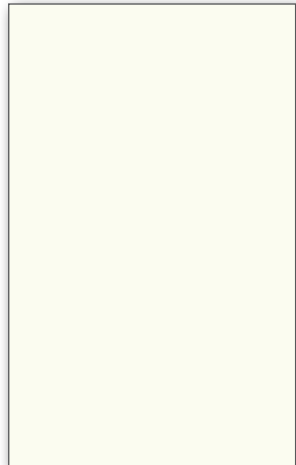

cenere (opz.9547)

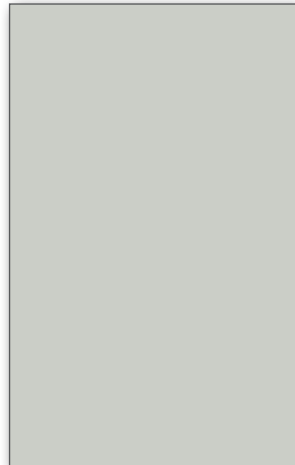

grigio traffico (opz.9511)

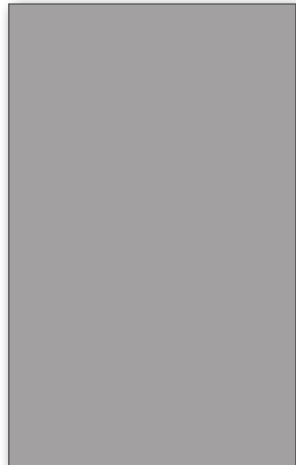

argilla (opz.9503)

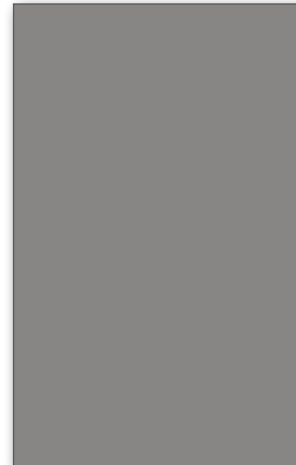

grigio bromo (opz.9533)

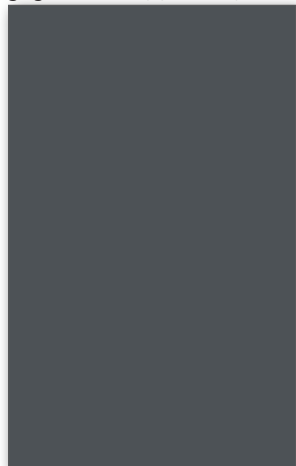

blu cristal (opz.8381)



nero seppia (opz.7897)

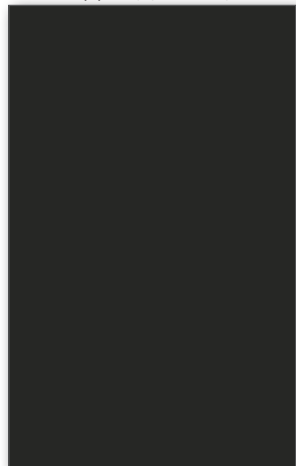

nero (opz.7892)



bianco caldo (opz.7401)

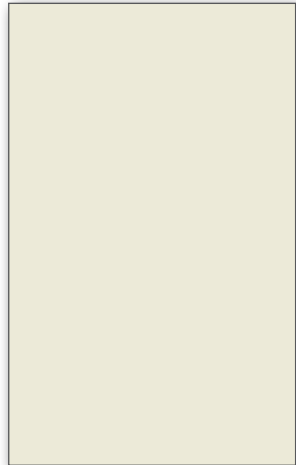

lino (opz.9513)

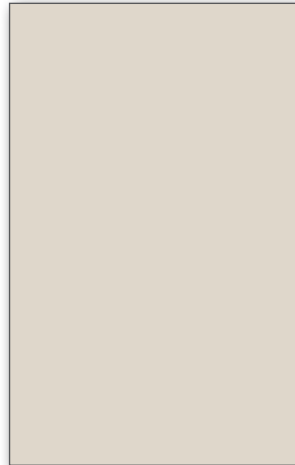

conchiglia (opz.7403)

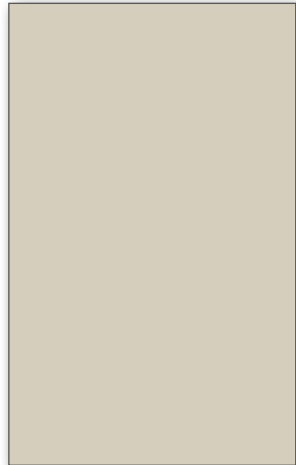

tortora (opz.8993)

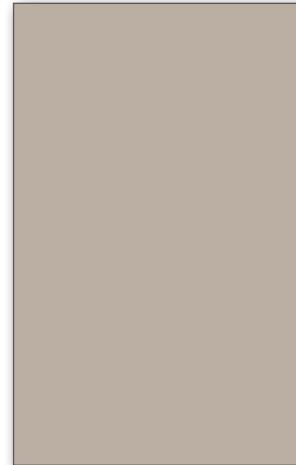

Neck cod. KC2  
Lux cod. KC3  
Bridge cod. KC1

nocciola (opz.7775)

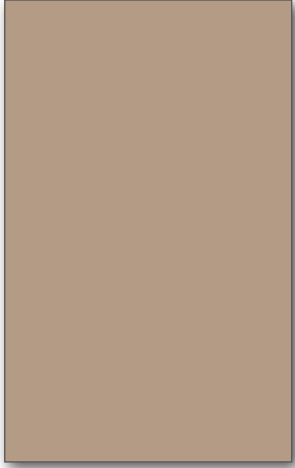

platino (opz.7773)

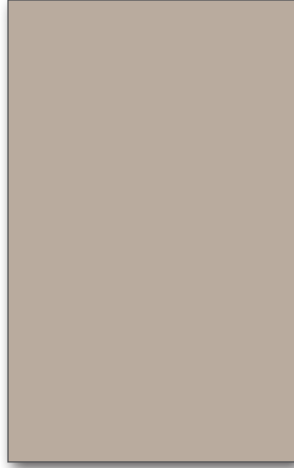

grigio kenya (opz.9501)

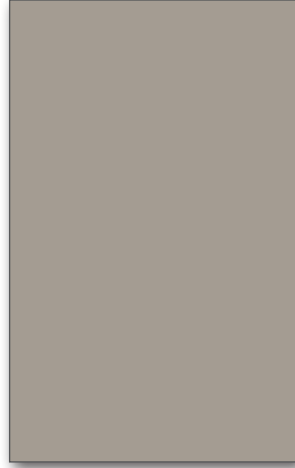

creta (opz.9515)

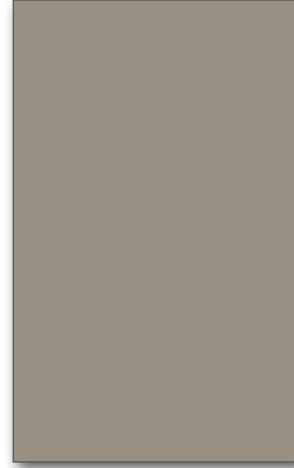

grigio reale (opz.95F3)

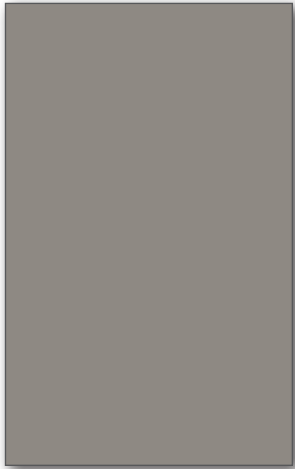

fumo (opz.9531)

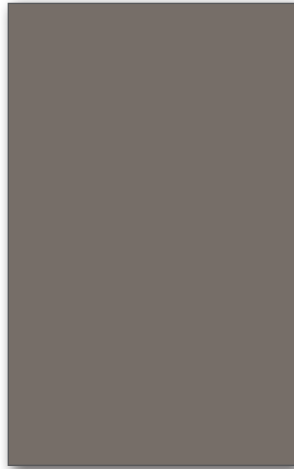

grigio quarzo (opz.95F7)



grigio piombo (opz.9537)

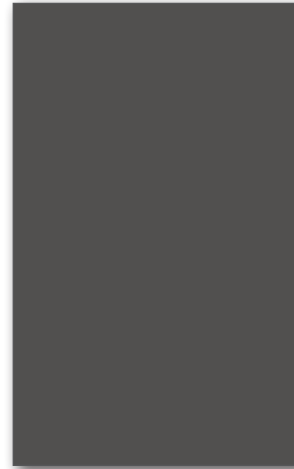

cuoio (opz.8897)



carruba (opz.89L1)

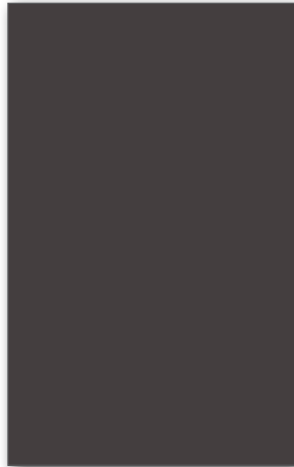

grigio lava (opz.95F1)

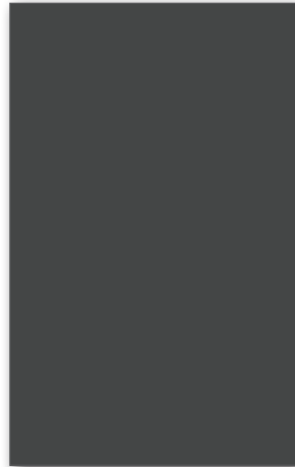

bistro (opz.9535)



# LACCATO OPACO

MATT LACQUERED

giallo digione (opz.8257)

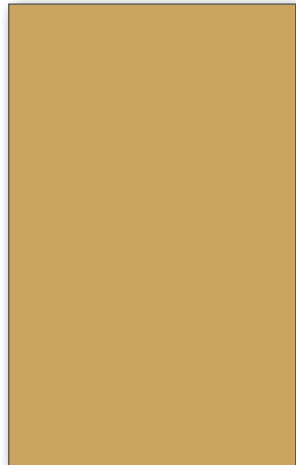

giallo zafferano (opz.8253)

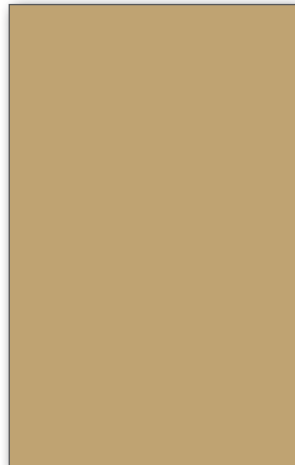

cannella (opz.8893)

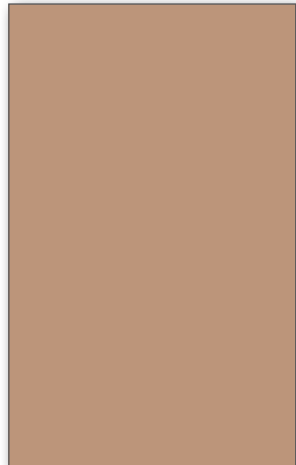

cotto (opz.8887)

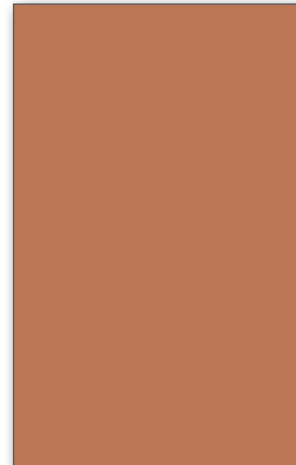

rosso (opz.125S)

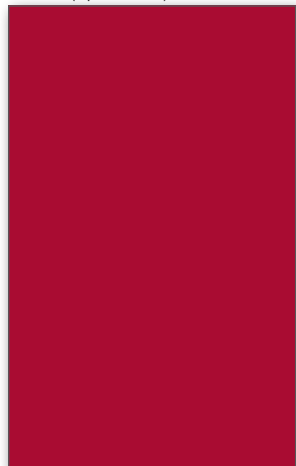

rosso persia (opz.8165)



granato (opz.8633)

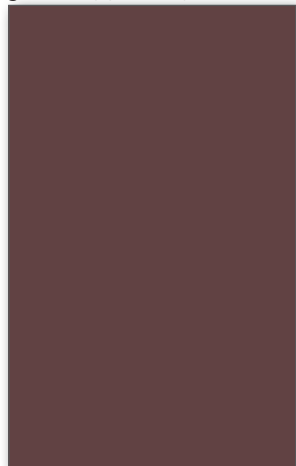

verde celadon (opz.8485)

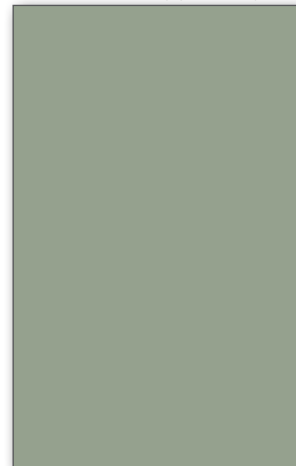

verde borneo (opz.8483)

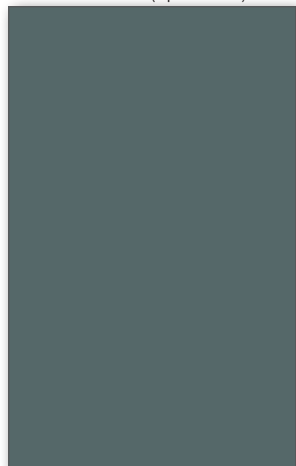

verde cinabro (opz.8481)

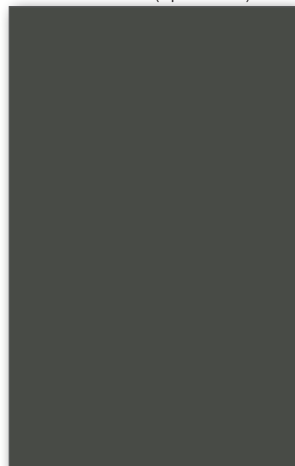

azzurro nube (opz.8379)

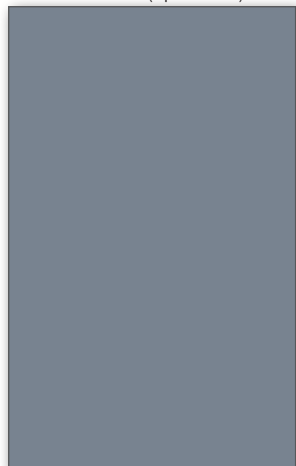

azzurro ottanio (opz.8385)

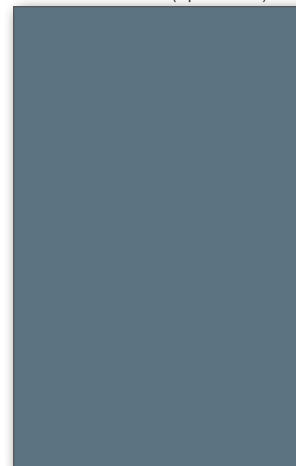



# LACCATO LUCIDO

GLOSSY LACQUERED

Anta sp.20 mm costituita da un pannello in fibra di legno (mdf.E5 certificato FSC, conforme US PA TSCA Title VI e CARB ATCM P2) laccato lucido poliuretano fronte, retro e bordo finitura 105 gloss.  
20 mm thick door consisting of a wood fiber panel (FSC-certified mdf.E5, complying with US PA TSCA Title VI and CARB ATCM P2) polyurethane glossy lacquer front, back and edge finish 105 gloss.

bianco assoluto (opz.741)

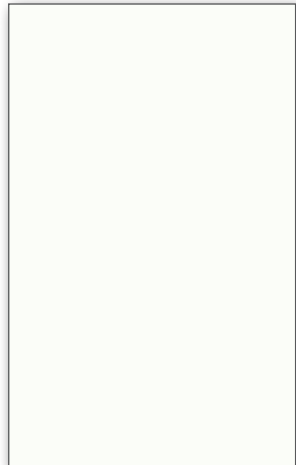

cenere (opz.9548)

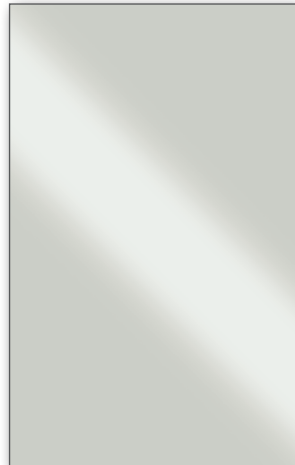

grigio traffico (opz.9512)

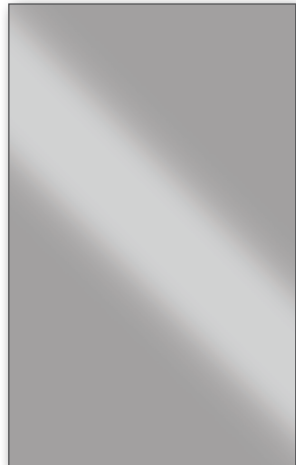

argilla (opz.9504)



grigio bromo (opz.9534)



blu cristal (opz.8382)



nero seppia (opz.7898)

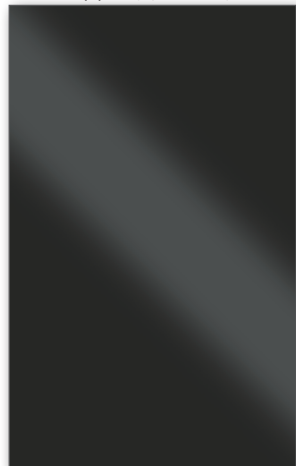

nero (opz.7893)



bianco caldo (opz.7402)

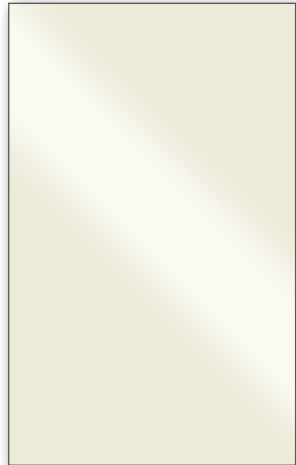

lino (opz.9514)

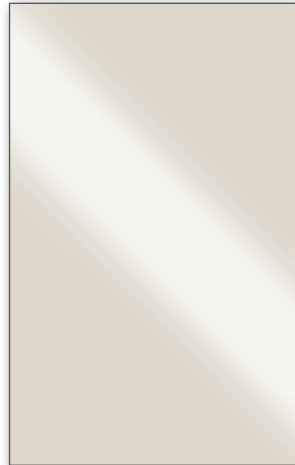

conchiglia (opz.7404)



tortora (opz.8994)

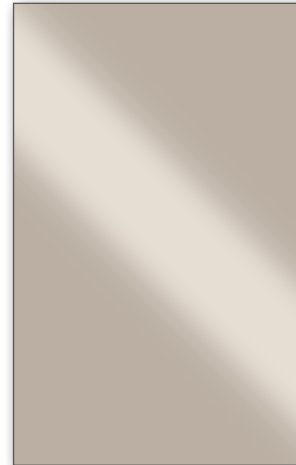

Neck cod. KC2  
Lux cod. KC3  
Bridge cod. KC1

grigio kenya (opz.9502)



creta (opz.9516)

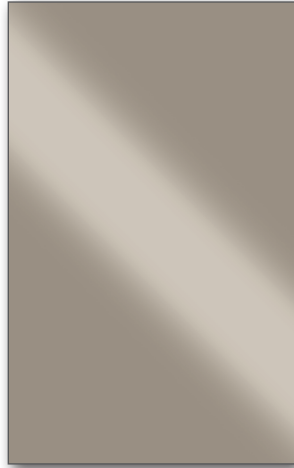

grigio reale (opz.95F4)

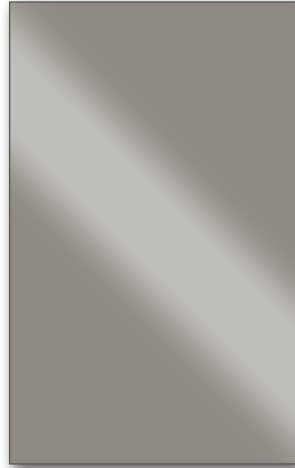

fumo (opz.9532)

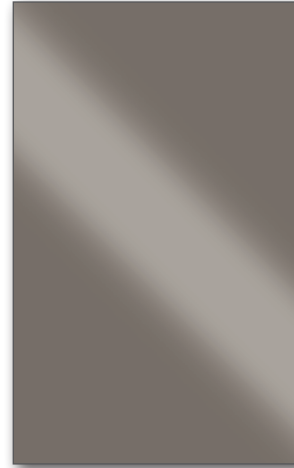

grigio quarzo (opz.95F8)



grigio piombo (opz.9538)



carruba (opz.89L2)

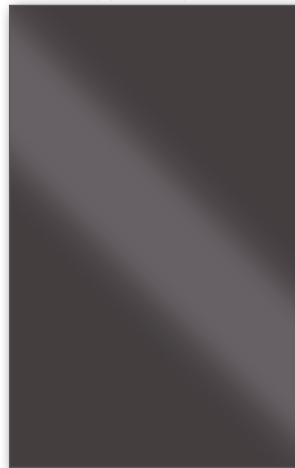

grigio lava (opz.95F2)



bistro (opz.9536)





giallo digione (opz.8258)

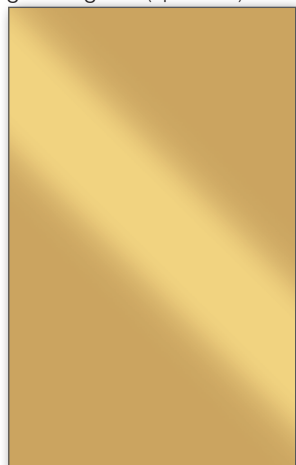

giallo zafferano (opz.8254)

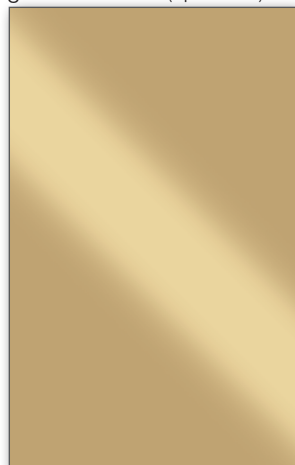

cannella (opz.8894)

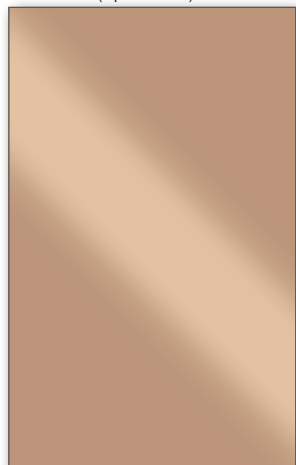

cotto (opz.8888)

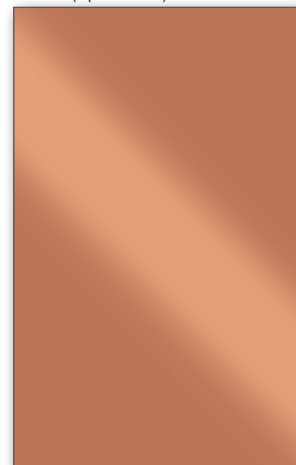

rosso (opz.126)



rosso persia (opz.8166)

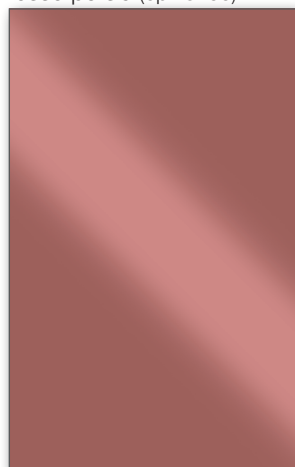

granato (opz.8634)

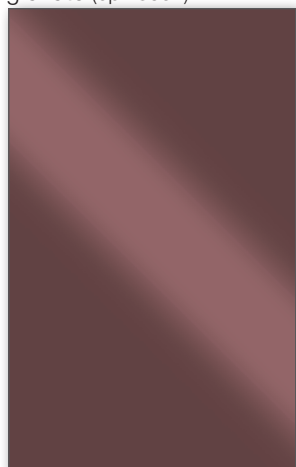

verde celadon (opz.8486)



verde borneo (opz.8484)

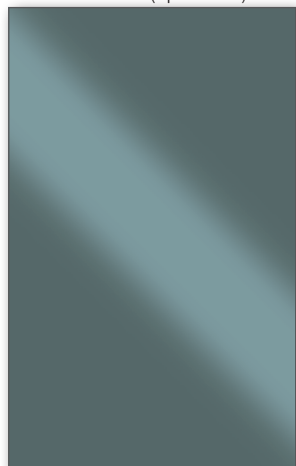

verde cinabro (opz.8482)

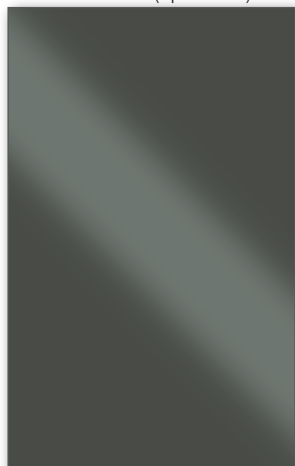

azzurro nube (opz.8380)

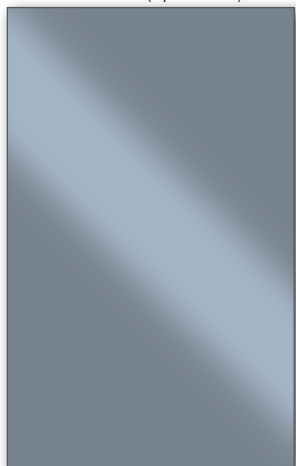

azzurro ottanio (opz.8386)





# LACCATO SUPER OPACO

SUPER MATT LACQUERED

Anta sp.20 mm costituita da un pannello di particelle di legno nobilitato 2 lati (conforme US EPA TSCA Title VI) bordato e laccato super opaco con tecnologia a eccimeri. Il retro è laccato in tinta con finitura 10 gloss micro testurizzata con superficie leggermente gofrata.

Door 20 mm thick made of 2-sided melamine-faced particleboard (US EPA TSCA Title VI compliant) edged and lacquered super-matte with excimer technology.

The back is lacquered in a 10-gloss micro textured finish with a slightly embossed surface.

bianco artico (opz.E002)

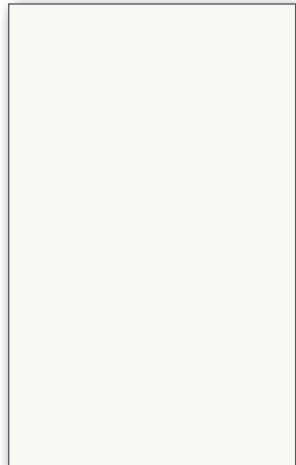

bianco 9010 (opz.E010)

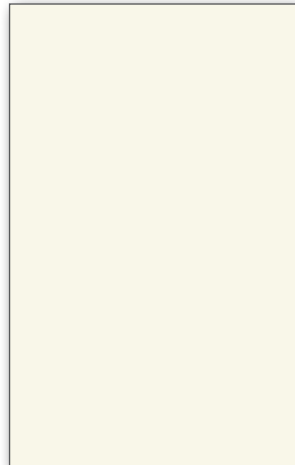

biscotto (opz.E021)

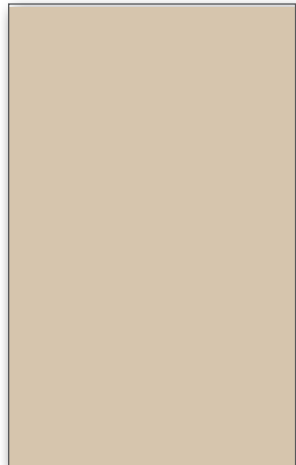

silicio (opz.E081)

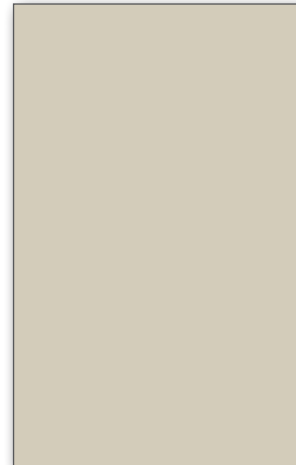

grigio islanda (opz.E121)

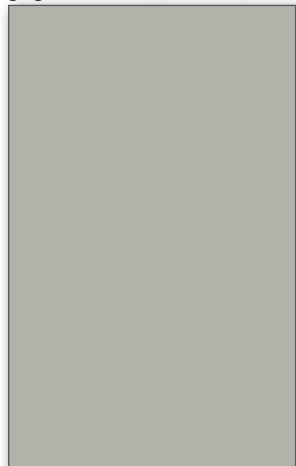

fossile (opz.E751)

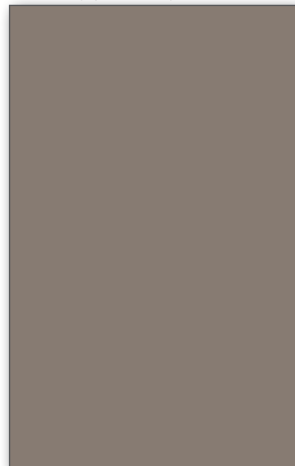

tartufo (opz.E651)

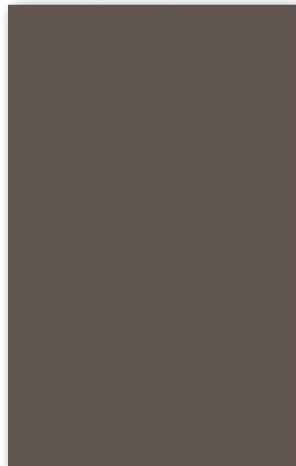

grigio luna (opz.E122)

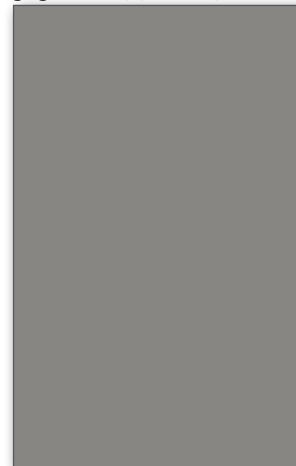

grigio etna (opz.E124)

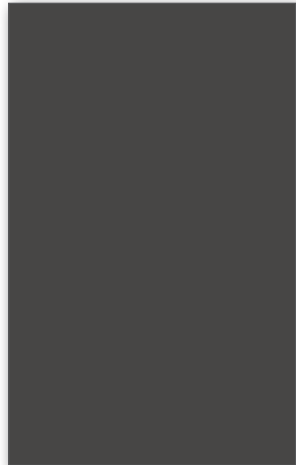

nero (opz.E101)

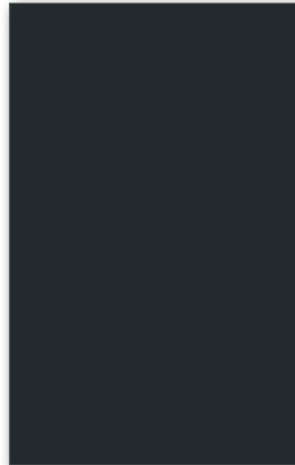

blu denim (opz.E401)

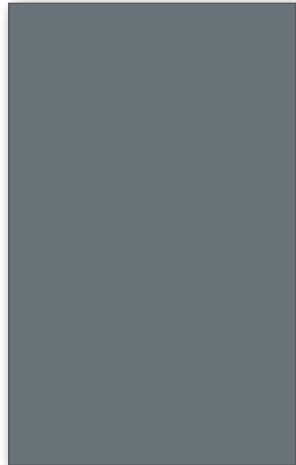

grigio nettuno (opz.E123)

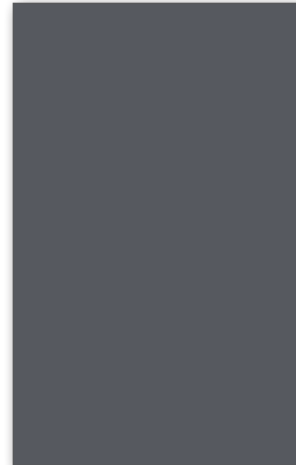

La nuova finitura a eccimeri super opaca permette di avere pannelli laccati a 0 gloss mantenendo elevate caratteristiche tecniche: totale opacità, anti riflesso, anti impronta e resistenza al graffio.

The new super-matte excimer finish allows for 0-gloss lacquered panels while maintaining high technical characteristics: total opacity, anti-glare, anti-fingerprint and scratch resistance.



**Neck** cod. KC2  
**Lux** cod. KC3  
**Bridge** cod. KC1

blu shaba (opz.E402)

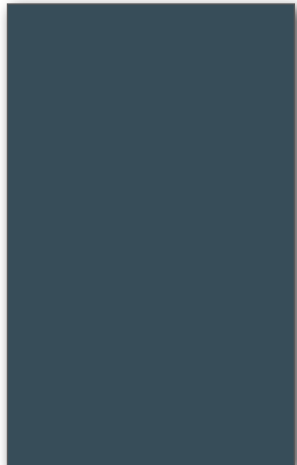

verde caraibi (opz.E551)

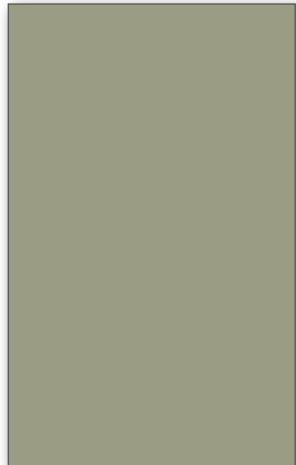

verde kitami (opz.E552)

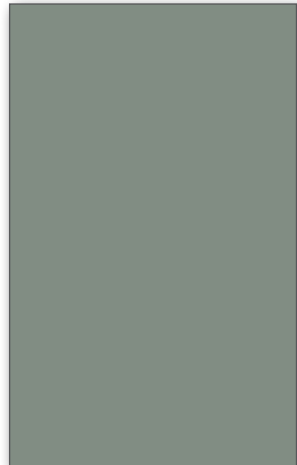

verde agave (opz.E553)

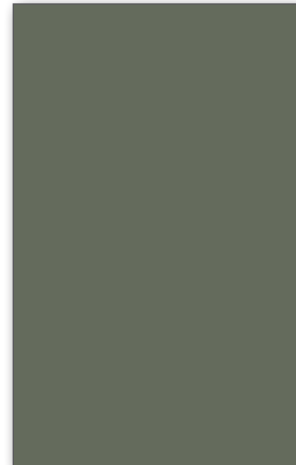

giallo autunno (opz.E301)

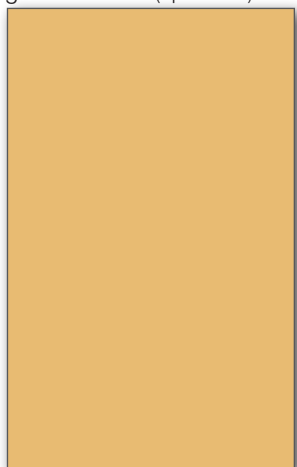

giallo evora (opz.E302)

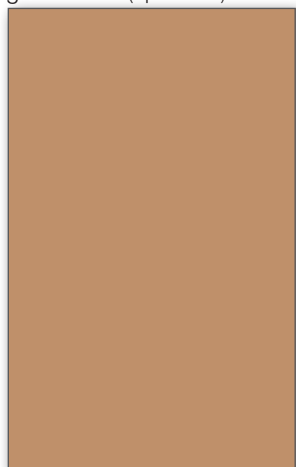

paprika (opz.E271)

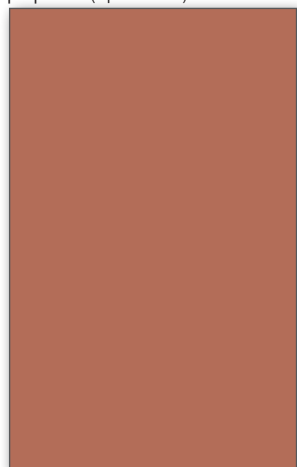

rosso fiamma (opz.E201)



rosa casale (opz.E251)

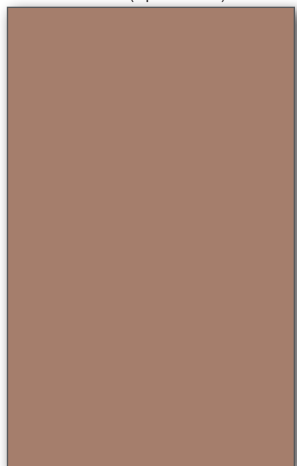

# LACCATO SUPER OPACO RAIN

SUPER MATT LACQUERED RAIN VERSION

Anta sp.20 mm costituita da un pannello in fibre di legno MDF (conforme US EPA TSCA Title VI) bordato con fronte rain (tramite pantografo) laccato super opaco con tecnologia a eccimeri. Il retro è laccato in tinta con finitura 10 gloss micro testurizzata con superficie leggermente goffrata.

20 mm thick door consisting of an MDF wood fiberboard (US EPA TSCA Title VI compliant) edged with rain front (by pantograph) lacquered super matt with excimer technology. The back is lacquered in a 10-gloss micro textured finish with a lightly embossed surface.

bianco artico (opz.E002C)

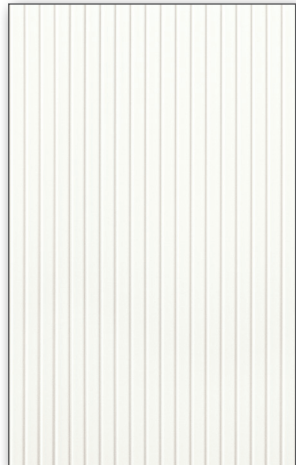

bianco 9010 (opz.E010C)

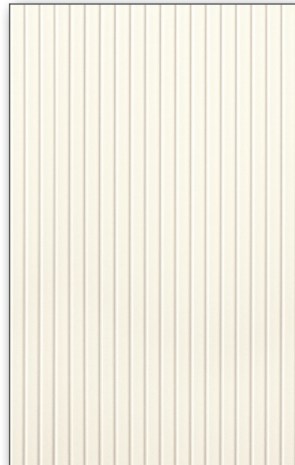

biscotto (opz.E021C)

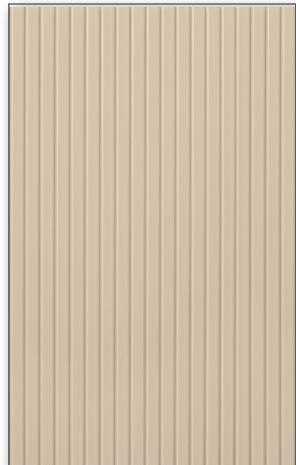

silicio (opz.E081C)

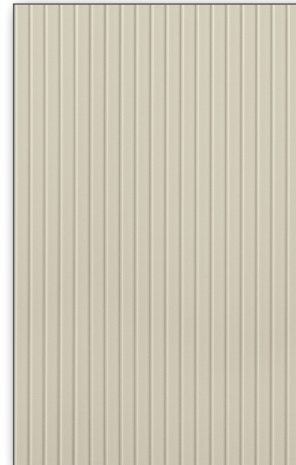

grigio islanda (opz.E121C)

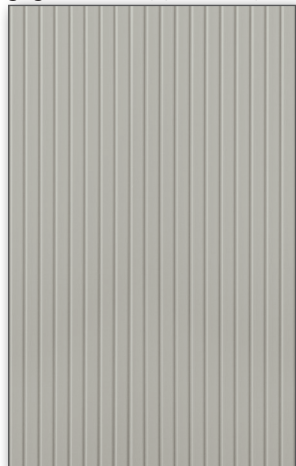

fossile (opz.E751C)

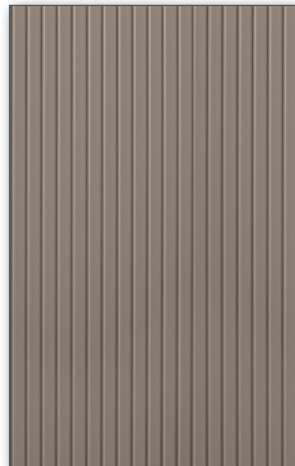

tartufo (opz.E651C)

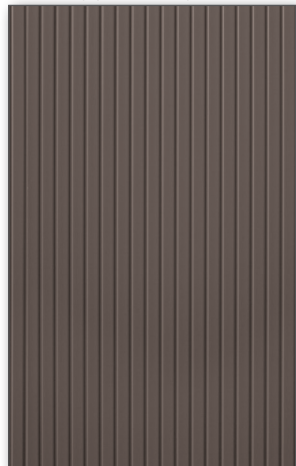

grigio luna (opz.E122C)

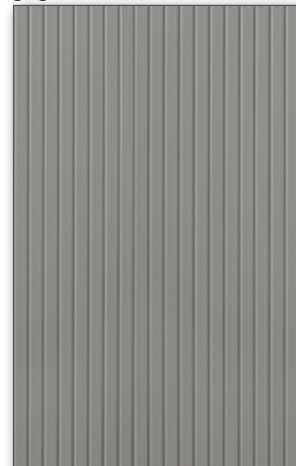

grigio etna (opz.E124C)

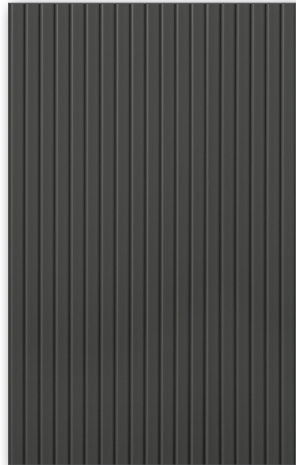

nero (opz.E101C)



blu denim (opz.E401C)

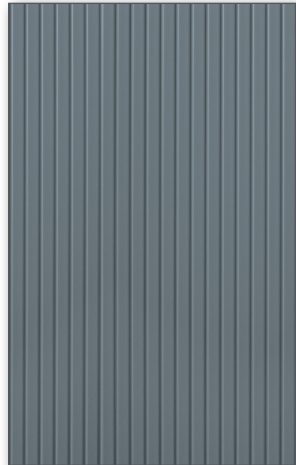

grigio nettuno (opz.E123C)



La nuova finitura a eccimeri super opaca permette di avere pannelli laccati a 0 gloss mantenendo elevate caratteristiche tecniche: totale opacità, anti riflesso, anti impronta e resistenza al graffio.

The new super-matte excimer finish allows for 0-gloss lacquered panels while maintaining high technical characteristics: total opacity, anti-glare, anti-fingerprint and scratch resistance.



Neck  
LUX

cod. KC2

cod. KC3

blu shaba (opz.E402C)

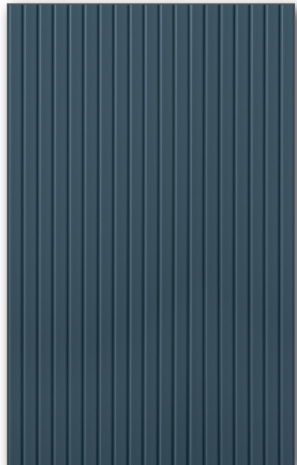

verde caraibi (opz.E551C)

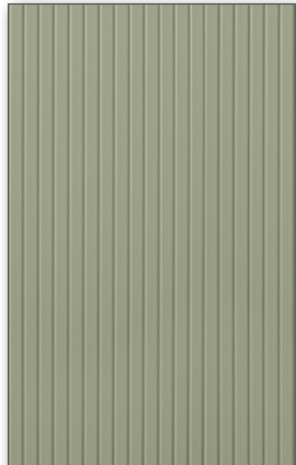

verde kitami (opz.E552C)

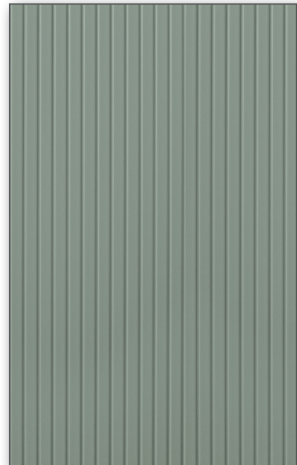

verde agave (opz.E553C)

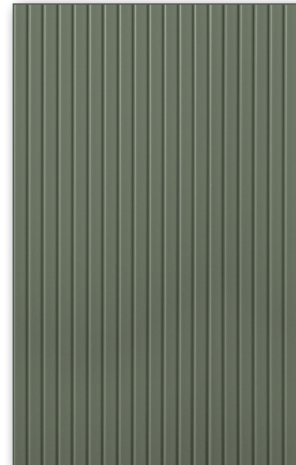

giallo autunno (opz.E301C)

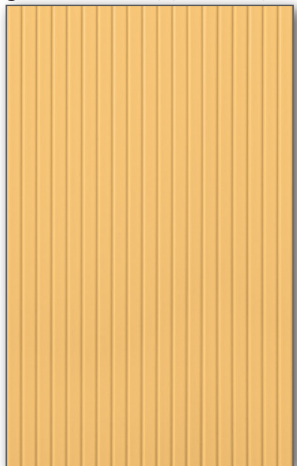

giallo evora (opz.E302C)

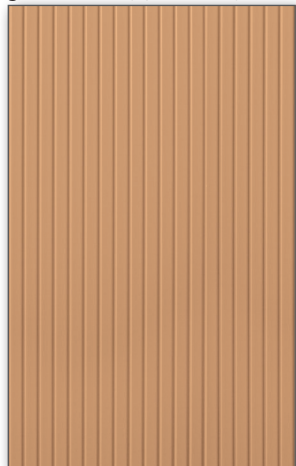

paprika (opz.E271C)

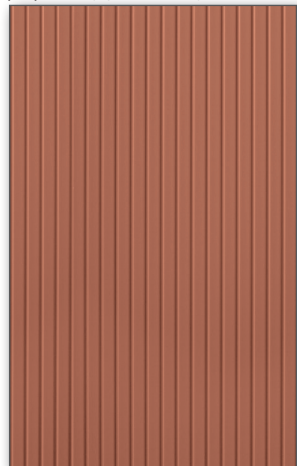

rosso fiamma (opz.E201C)

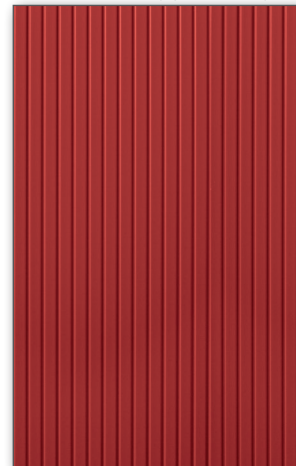

rosa casale (opz.E251C)

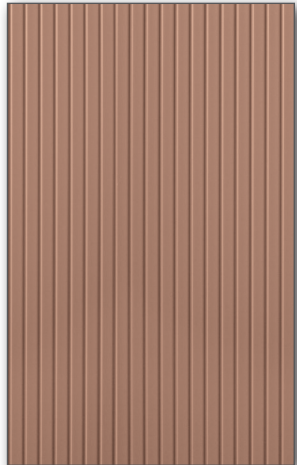

La versione rain è disponibile solo NECK e LUX. Non disponibile in variante BRIDGE con maniglia.  
The rain version is only NECK and LUX available. Not available in BRIDGE version with handle.

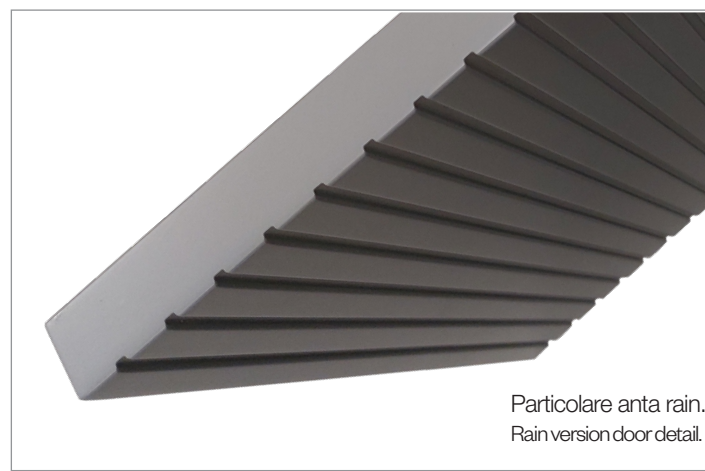

Particolare anta rain.  
Rain version door detail.

# LACCATO VINTAGE

VINTAGE LACQUERED

anta sp.20 mm costituita da un pannello MDF (conforme US EPA TSCA Title VI) laccato effetto vintage  
20 mm thick door made of a MDF panel (compliant with US EPA TSCA Title VI) vintage effect lacquered.

Neck cod. KC2  
Lux cod. KC3  
Bridge cod. KC1

## EFFETTO METALLO METAL EFFECT

ferro (opz.9506)



bronzo (opz.8904)



peltro (opz.9549)







## CERNIERA 110° BLUMOTION DI SERIE

STANDARD 110° BLUMOTION HINGES

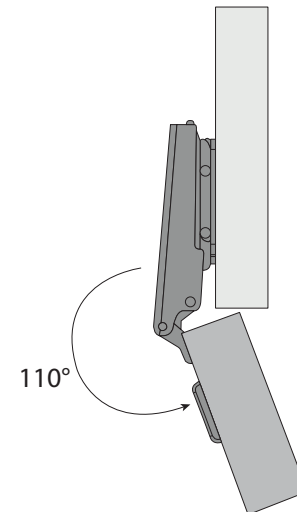
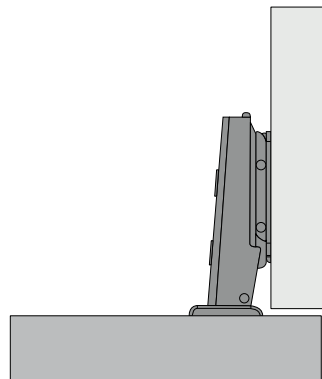
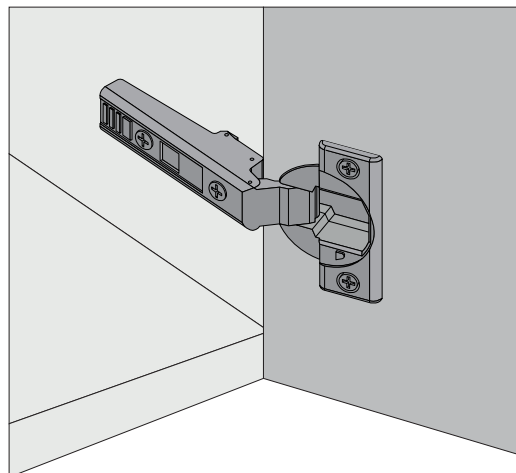

## CERNIERA 155° BLUMOTION

155° BLUMOTION HINGES

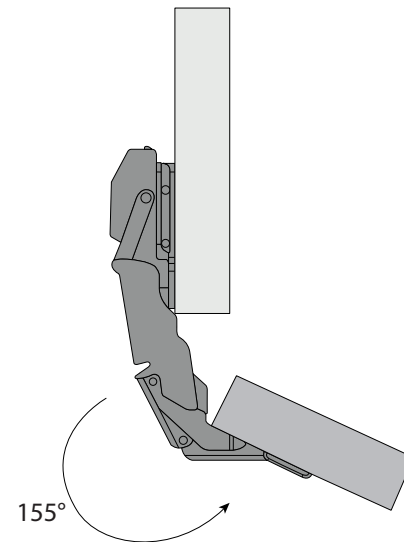
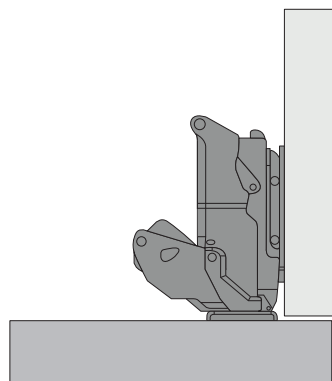
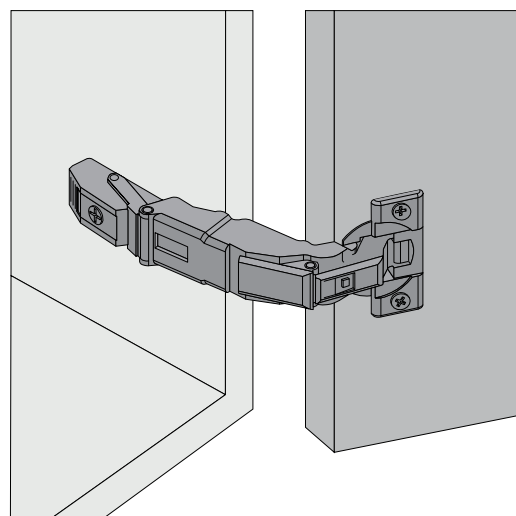

**!** Le cerniere 155° Blumotion nei pensili sono a richiesta. Sono invece di serie nei pensili colapiatti. Blumotion 155° hinges in wall units are optional. They are, however, standard in the plate rack wall units.

## APERTURA A RIBALTA

FLAP OPENING

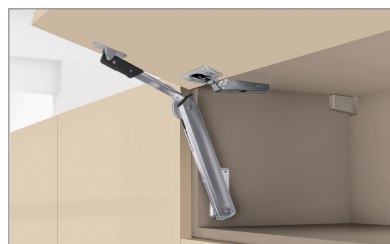
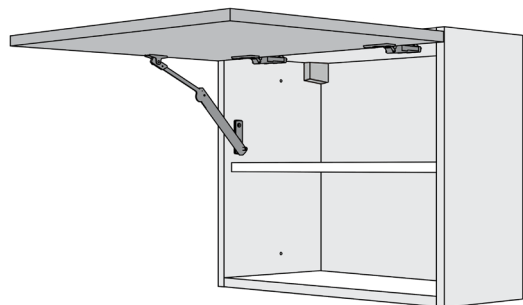

DI SERIE  
STANDARD

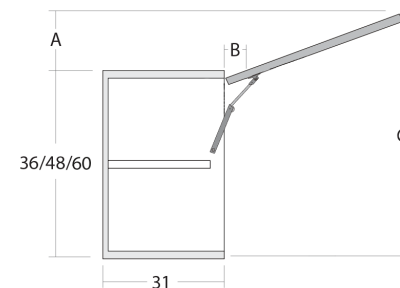

	A	B	C
H 36	10	2,3	46
H 48	13	2,3	61
H 60	17,2	2,3	77,2

## APERTURA VERTICALE OBLIQUA

OBLIQUE VERTICAL OPENING

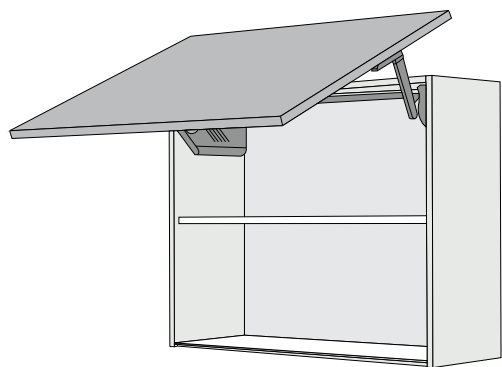

**DI SERIE**  
STANDARD



**MOTORIZZATO**  
**SERVO-DRIVE**  
SERVO-DRIVE  
MOTORIZED  
(Opz. 007)

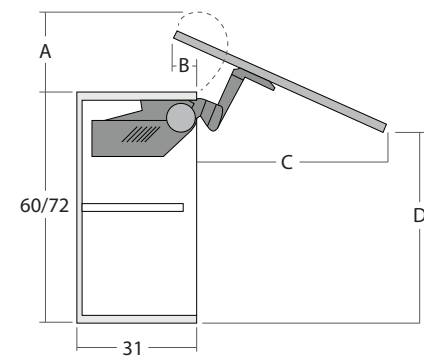

	A	B	C	D
<b>H 60</b>	18	9,6	46,5	53,5
<b>H 72</b>	18	9,6	57	61

## APERTURA ANTE A PACCHETTO

LIFT-UP FOLDING OPENING

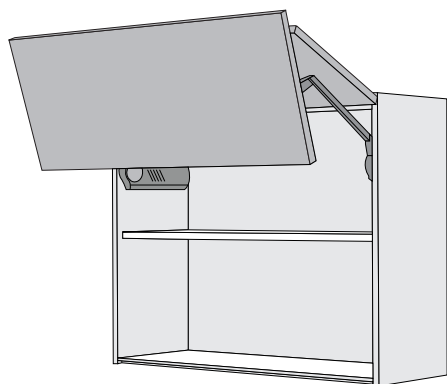

**DI SERIE**  
STANDARD



**MOTORIZZATO**  
**SERVO-DRIVE**  
SERVO-DRIVE  
MOTORIZED  
(Opz. 007)

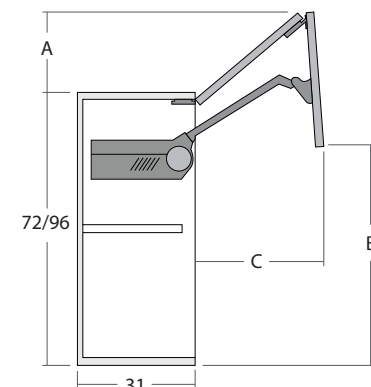

	A	B	C
<b>H 72</b>	19,5	54	41
<b>H 96</b>	24,7	69	53

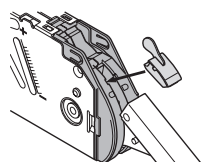

Limitatore angolo di apertura  
cod. 5620005  
Opening angle limiter  
code 5620005

## CERNIERA 110° BLUMOTION DI SERIE

STANDARD 110° BLUMOTION HINGES

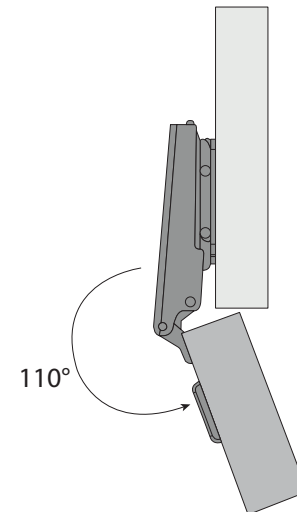
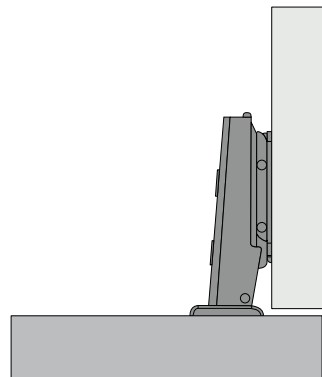
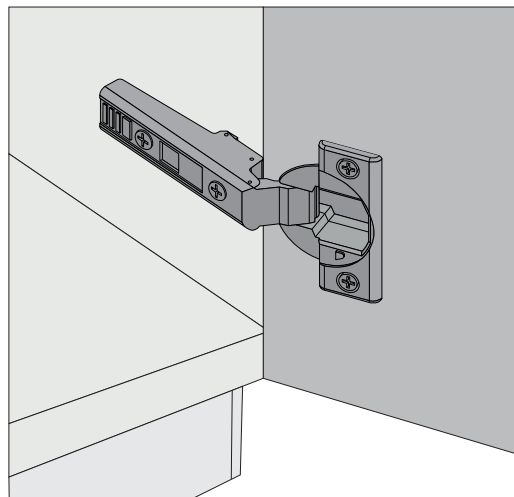

## CERNIERA 155° BLUMOTION

155° BLUMOTION HINGES

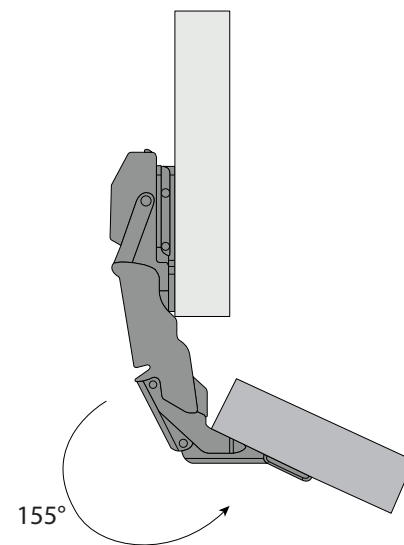
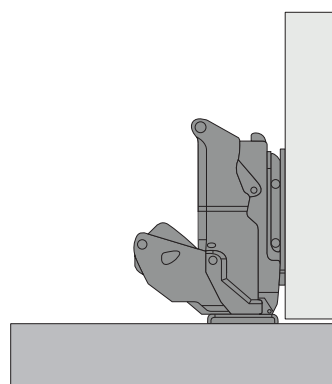
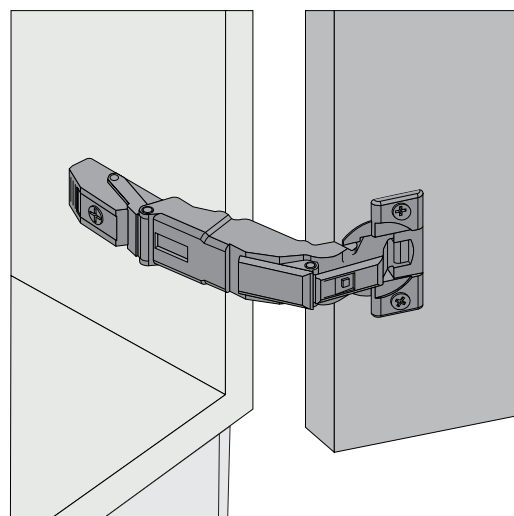

Le cerniere 155° Blumotion sono a richiesta. Sono invece di serie nelle basi angolo 95x95 e 110x110 e nelle basi e colonne con anta più cassetti, cestoni ed accessori estraibili interni. Blumotion 155° hinges are optional. They are, however, standard in the 95x95 and 110x110 corner bases and in the bases and columns with a door plus internal drawers, baskets and extractable accessories.

## CERNIERA PILASTRO BLUMOTION

PILLAR BLUMOTION HINGES

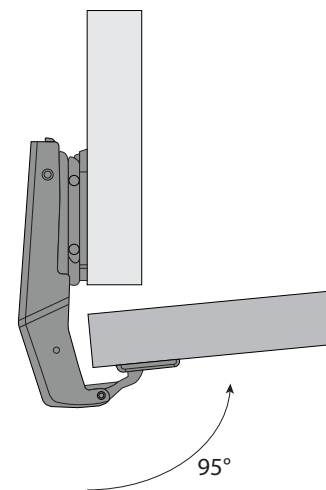
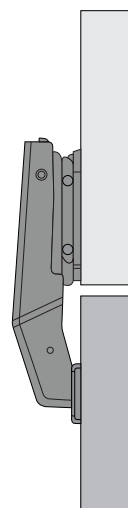
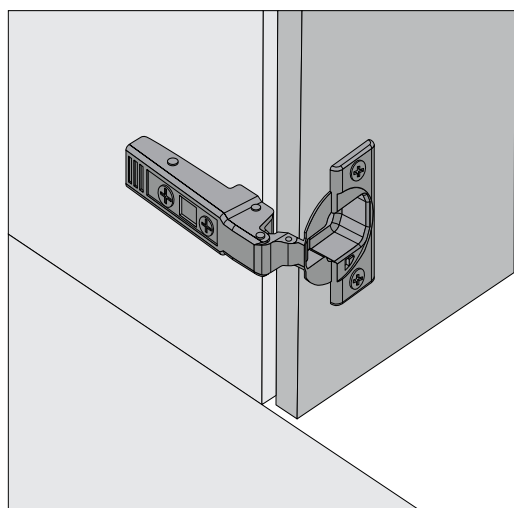

Le cerniere pilastro Blumotion sono di serie nelle basi angolo e nelle colonne angolo. Pillar Blumotion hinges are standard in the corner base units and in the corner columns.

# CASSETTI E CESTONI "ANTARO"

"ANTARO" DRAWERS AND BASKETS

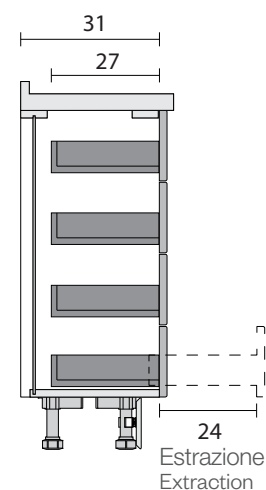
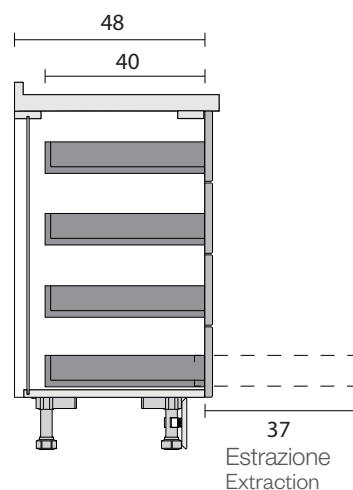
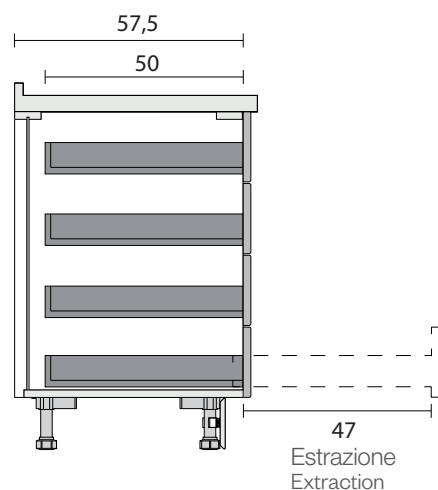
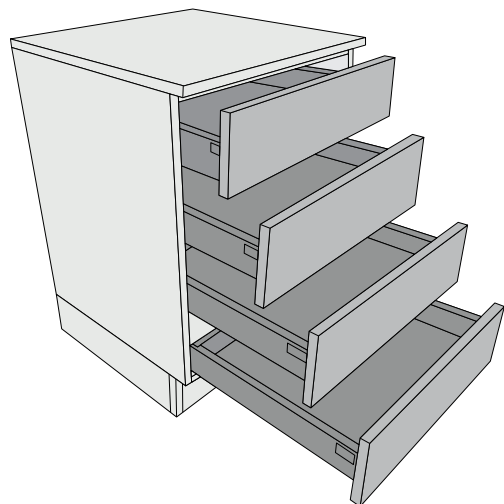

I sistemi "Intivo" garantiscono l'estrazione totale dei cassetti e cestoni e sono equipaggiati con fermo di fine corsa e sistema ad incastro per bloccaggio anti-sganciamento. Nei cassetti e cestoni con larghezza fino a 120 cm la portata dinamica è di 50 kg e 30 kg nelle profondità ridotte. Il movimento silenzioso ed ammortizzato è garantito per oltre 100.000 cicli di apertura/chiusura.

"Intivo" systems ensure full extraction of drawers and baskets and are equipped with end stop and interlocking system for anti-release locking. In drawers and baskets with widths up to 120 cm, the dynamic load capacity is 50 kg and 30 kg in shallow depths. The quiet, damped movement is guaranteed for more than 100,000 opening/closing cycles.

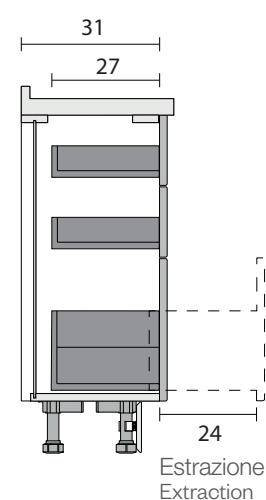
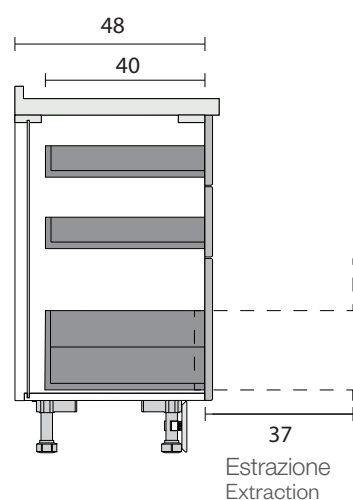
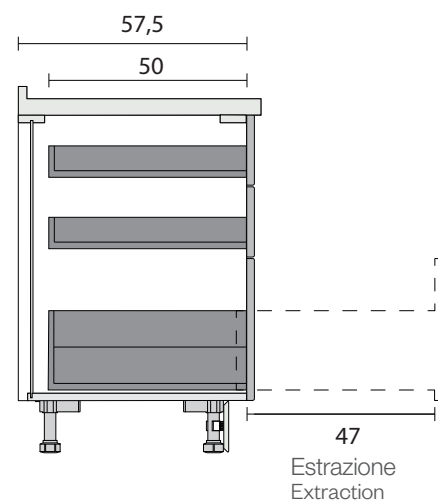
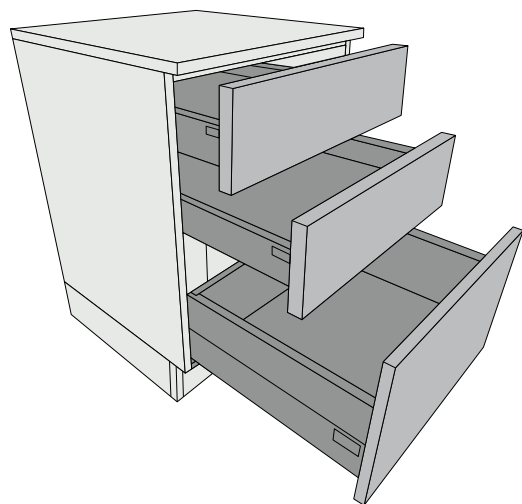

## CONSULTA EXTRANET:

- CONSULT ON EXTRANET:  
 - Accessori e meccanismi interni  
 - Accessories and internal mechanisms



## DETTAGLIO CASSETTO E CESTONE "ANTARO"

DETAIL OF "ANTARO" DRAWER AND BASKETS



Finitura "Orion Grau"  
 "Orion Grau" finish

GRUPPOLUBE



INSIDE-K  
 LISTINO 2023

