



*Kyra Telaio
Neck*



*Kyra Telaio
Vintage*



*Kyra Telaio
Bridge*



*Vivi Kyra
Telaio nei
suoi stili*

**ABSORB THE CHARM OF
KYRA FRAME IN ITS
VARIOUS STYLES**

La gamma del programma KYRA si amplia con la proposta della versione con anta a telaio. KYRA TELAIO vive negli stili: Neck senza maniglia, Bridge con maniglia e Vintage. Per caratterizzare gli ambienti cucina e living in modo originale, accostando ante a telaio ad ante lisce proposte nelle stesse finiture e colori.

The KYRA project range broadens with our new framed cabinet version. KYRA FRAME is available in the following styles: Neck without handles, Bridge with handles and Vintage. Give kitchen and living space a distinctive touch by combining framed cabinetry with frameless cabinetry available in the same finishes and colours.



12
Abete Nordico Bianco
White Nordic fir



18

Rovere Naturale Vintage
Vintage natural oak



24

Abete Nordico Bianco
White Nordic fir



Index

Preziosa ed accuratamente scelta è la gamma delle proposte di CREO Kitchens per il modello KYRA Telaio. Le ambientazioni presentate in questo catalogo ne valorizzano le molteplici possibilità compositive e di design, mettendo in evidenza l'alta qualità dei prodotti CREO Kitchens.

CREO Kitchens propose an alluring and carefully selected array of items for their KYRA FRAME model. In this catalogue, a variety of settings have been chosen to showcase the various possible design options and compositions available and to enhance the superior quality of CREO Kitchens' products.

Lavorazioni romanticamente vintage

A ROMANTIC VINTAGE EFFECT





Colonne ribassate, basi con ante a telaio in melaminico nella finitura Abete Nordico Bianco, pensili con ante lisce nella finitura Glaks Rosa Colorado, pensili con ante a telaio in melaminico nella finitura Abete Nordico Bianco e vetro stampato Screen, elementi a giorno color Rosa Quarzo.

Low columns, base units with framed cabinetry in a melamine White Scandinavian Pinewood finish, wall units with frameless cabinetry in a Glaks Colorado Pink finish, wall units with framed cabinetry in a melamine White Scandinavian Pinewood finish with screen-printed glass panels and open units in Quartz Pink.

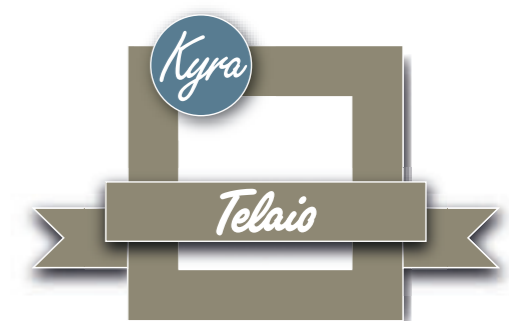



Progetto per valorizzare grandi spazi

IDEAS TO USE LARGE SPACES TO ADVANTAGE





Colonne ribassate con ante lisce nella finitura laccato Bianco Caldo, Basi con ante a telaio in melaminico finitura Rovere naturale Vintage, pensili con ante a telaio nella finitura laccato Peltro e vetro retinato.

Low columns with frameless cabinetry in a Warm White lacquered finish, Base units with framed cabinetry in a melamine natural Oak finish and wall units with framed cabinetry in a lacquered Pewter finish with textured glass panels.

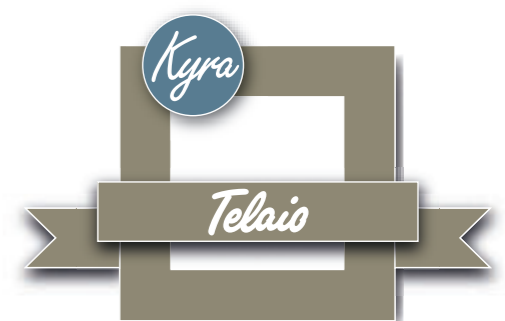



Armonioso equilibrio di forme

TASTEFUL HARMONIOUS PROPORTIONS





Colonne con anta a telaio in melaminico nella finitura Abete Nordico Bianco e con anta liscia nella finitura laccato Verde Lichene, colonne profondità ridotta con ante a telaio in melaminico nella finitura Abete Nordico Bianco e vetro stampato Screen. Basi, pensili con ante a telaio in melaminico nella finitura Abete Nordico Bianco e vetro stampato Screen, elementi a giorno Verde Lichene.

Columns with framed cabinetry in a melamine White Scandinavian Pinewood finish and with frameless cabinetry in a lacquered Moss Green finish, narrower columns with framed cabinetry in a melamine White Scandinavian Pinewood finish with screen-printed glass panels. Base units, wall units with framed cabinetry in a melamine White Scandinavian Pinewood finish and screen-printed glass panels and Moss Green open units.



Area Tecnica

TECHNICAL AREA

Nelle prossime pagine sono presenti schede descrittive delle composizioni cucina e living del modello KYRA TELAIO proposte in questo catalogo. Uno strumento per facilitarti nella scelta delle finiture, degli abbinamenti e delle dimensioni per un adeguato inserimento dei nostri prodotti nell'ambiente in cui verranno installati.

The following pages feature data sheets that describe the KYRA FRAME kitchen and living room compositions presented in this catalogue. This tool is designed to help you choose finishes, combinations and dimensions to allow our products to fit correctly into the areas they are to be installed in.



pg. 12

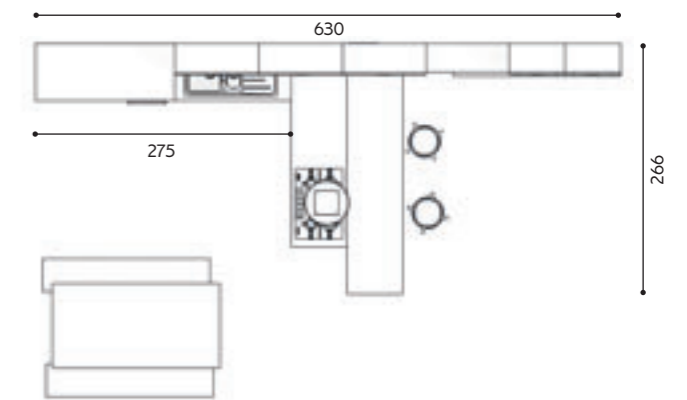

Finiture e colori ante
Doors colours and finishes



Finiture e colori top
Top colours and finishes



Maniglia
Handle



Maniglia incassata 581 finitura bronzo titanio
Built-in handle 581 titanium bronze finish



pg. 18

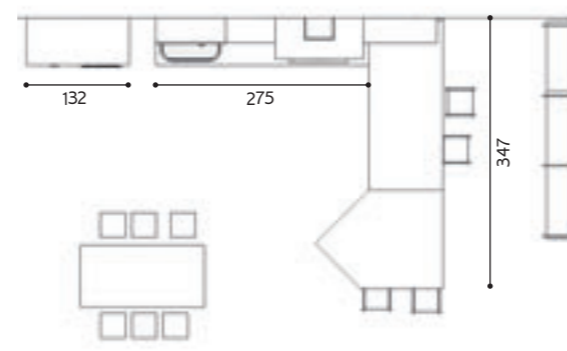

Finiture e colori ante
Doors colours and finishes

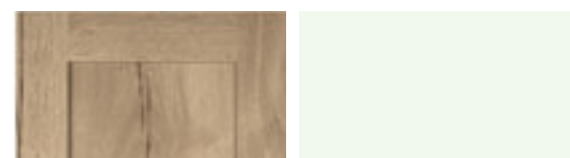

Finiture e colori top
Top colours and finishes

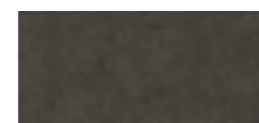

Maniglia
Handle



Gola in alluminio colore Peltro
Aluminium finger rail Pewter finish



pg. 24

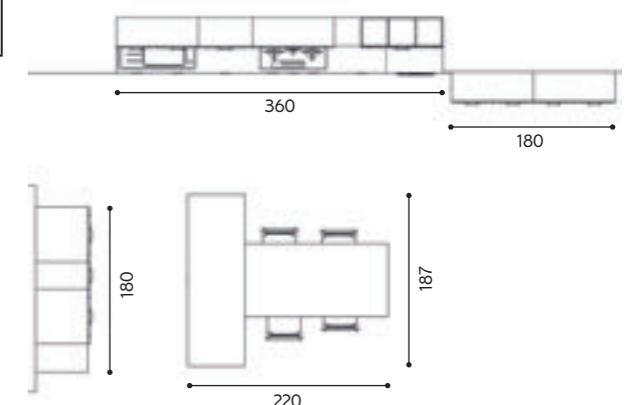

Finiture e colori ante
Doors colours and finishes



Finiture e colori top
Top colours and finishes



Maniglia
Handle



Maniglia K82 finitura nichel satinato
Handle K82 satin nickel finish

kyra telaio

melaminico sp. 20 mm

kyra frame

melamine th. 20 mm

BRIDGE ^{cod.} **K25**

NECK ^{cod.} **KG5**

Finiture e Colori Kyra Telaio

FINISHES AND COLOURS KYRA FRAME

La vasta gamma proposta da CREO Kitchens di finiture, dall'aspetto tattile e visivo, raffinato e seducente e dei colori declinati in proposte attuali ed emozionali, permettono di creare l'identità della tua cucina. Tatto e vista interagiscono nella personalizzazione del tuo ambiente cucina.

The vast range of finishes offered by Creo Kitchens, with refined tactile and visual qualities and contemporary and exciting colours allow you to create your kitchen's identity. Touch and sight interact to customise your kitchen area.

ante a telaio finitura sincro poro effetto vintage
frame doors with sync pore finish vintage effect

 *colori in pronta consegna*
available colours



abete nordico bianco (opz.4406)
white nordic fir (opt.4406)



rovere naturale vintage (opz.5310)
vintage natural oak (opt.5310)

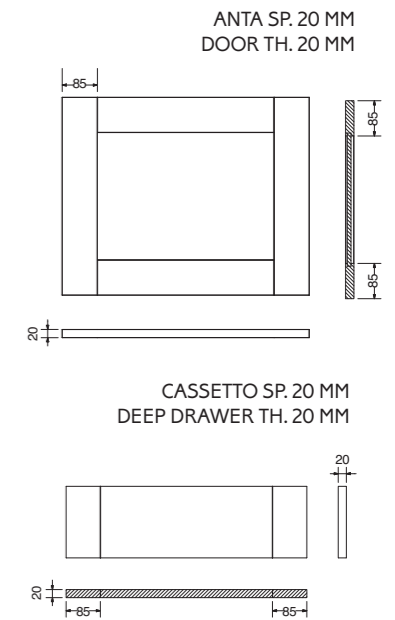

ante a telaio finitura sincro poro effetto vintage
con vetro stampato Screen

frame sync pore finish vintage effect and Screen printed glass

 *colori in pronta consegna*
available colours



abete nordico bianco (opz.4406)
white nordic (opt.4406)



rovere naturale vintage (opz.5310)
vintage natural oak (opt.5310)

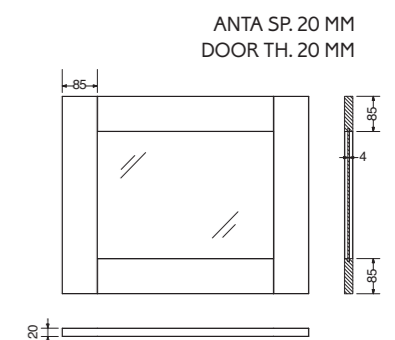

CARATTERISTICHE TECNICHE

TECHNICAL SPECIFICATIONS

ANTE DOORS anta a telaio in melaminico sincro poro effetto vintage fiamma verticale sp.20 mm bordata su tutti i lati interni ed esterni con pannello sp.8 mm nei colori opachi: abete nordico bianco (opz.4406), abete nordico terra (opz.4407), rovere naturale vintage (opz.5310)

melamine-faced door with frame th.20 mm, vertical grain, sync pore with vintage effect, bordered on the internal and external sides with th.8 mm panel in the following matt colours: white nordic fir (opt.4406), earth nordic fir (opt.4407), vintage natural oak (opt.5310)

FRONTALI CASSETTI DRAWERS FRONTS in melaminico sincro poro effetto vintage fiamma verticale sp.20 mm nei colori opachi: abete nordico bianco (opz.4406), abete nordico terra (opz.4407), rovere naturale vintage (opz.5310)

melamine-faced panel, Th. 20 mm, with vertical grain sync pore vintage effect in the following matt colours: white nordic fir (opt.4406), earth nordic fir (opt.4407), vintage natural oak (opt.5310)

ANTE VETRO GLASS DOORS telaio in melaminico sincro poro effetto vintage sp.20 mm, nei colori opachi: abete nordico bianco (opz.4406), abete nordico terra (opz.4407), rovere naturale vintage (opz.5310), con vetro stampato Screen

melamine-faced frame Th. 20 mm, panel and border on the internal and external sides. Frame with vertical grain, sync pore with vintage effect in the following matt colours: white nordic fir (opt.4406), earth nordic fir (opt.4407), vintage natural oak (opt.5310), with Screen printed glass

STRUTTURE CARCASSES ANTE: ABETE NORDICO BIANCO, ROVERE NATURALE VINTAGE nobilitato visone (opz.948M) schiena e ripiano visone (opz.948M)
ANTA: ABETE NORDICO TERRA nobilitato perla d'oriente (opz.940), schiena e ripiano bianco (opz.001)

DOORS: WHITE NORDIC FIR, VINTAGE NATURAL OAK melamine-faced mink (opt.948M), mink (opt.948M) back panel and shelf

DOOR: EARTH NORDIC FIR melamine-faced oriental pearl (opt.940), white (opt.001) back panel and shelf



MENSOLE SHELVES di serie: altezza 3,8 cm in laminato bianco (opz.001), perla d'oriente (opz.940), visone (opz.948M)
a richiesta: altezza 3,8 cm in melaminico abete nordico bianco (opz.4406), abete nordico terra (opz.4407), rovere naturale vintage (opz.5310)

standard: height 3.8 cm, laminate in the colours white (opt.001), oriental pearl (opt.940), mink (opt.948M)
on request: height 3.8 cm melamine-faced, white nordic fir (opt.4406), earth nordic fir (opt.4407), vintage natural oak (opt.5310)

MANIGLIE/HANDLES Per modello KYRA TELAIO Bridge, di serie e a richiesta: VEDI RIFERIMENTO LISTINO KYRA Bridge
KYRA FRAME Bridge model, standard and on request: SEE PRICE LIST KYRA Bridge

GOLE/FINGER RAILS Per modello KYRA TELAIO Neck: vedere lista a seguire
KYRA FRAME Neck model: see following list

gola di serie
standard finger rail



alluminio lucido (opz.410)
polished aluminium
(opt.410)

finitura gola spazzolata
finger rail brushed finish

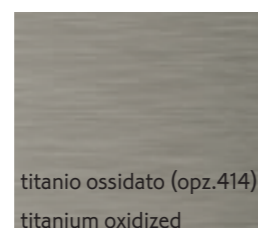

titanio ossidato (opz.414)
titanium oxidized

finitura gola laccata vintage
finger rail vintage lacquered finish

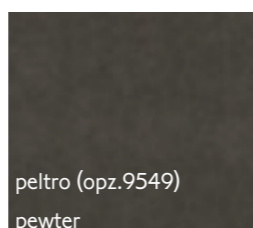

peltro (opz.9549)
pewter

finiture gole verniciate a polvere opache
matt finger rails powder coated finishes



ZOCCOLI PLINTHS di serie per modello KYRA TELAIO Bridge: altezza 15 cm in pvc ricoperti in melamina finitura acciaio (opz.407)
di serie per modello KYRA TELAIO Neck: altezza 13 cm in pvc ricoperti in melamina finitura acciaio (opz.407)

standard for KYRA FRAME Bridge: height 15 cm, melamine-faced pvc with steel finish (opt.407)
standard for KYRA FRAME Neck: height 13 cm, melamine-faced pvc with steel finish (opt.407)

zoccoli in pvc H 13-15
pvc plinths H 13-15



acciaio (opz.407)
steel (opt.407)



alluminio satinato (opz.405)
satin aluminium
(opt.405)



bianco (opz.001)
white (opt.001)



laccato peltro (opz.L9549)
pewter lacquered
(opt.L9549)

zoccoli in pvc H 13-15 laccato peltro
pvc plinths H 13-15 pewter lacquered

zoccoli in alluminio H 13-15
aluminium plinths H 13-15



alluminio finitura brill (opz.412)
aluminium with
brill finish (opt.412)



alluminio bianco semilucido (opz.A001)
semi-polished white
aluminium (opt.A001)



alluminio finitura titanio ossidato (opz.414)
aluminium titanium
oxidized finish (opt.414)

zoccoli in alluminio H 13-15 verniciati a polvere finitura opaca
aluminum plinth height H 13-15 powder coated matt finish



alluminio finitura nero (opz.7892)
aluminium
black finish (opt.7892)



alluminio finitura giallo ambra (opz.8225)
aluminium amber
yellow finish (opt.8225)



alluminio finitura rosso corallo (opz.8131)
aluminium coral red
finish (opt.8131)



alluminio finitura salvia (opz.8443)
aluminium sage
finish (opt.8443)



alluminio finitura bianco assoluto (opz.7405)
aluminium absolute
white finish (opt.7405)



alluminio finitura acquamarina (opz.8323)
aluminium aquamarine
finish (opt.8323)



alluminio finitura bruno antilope (opz.9451)
aluminium antelope brown
finish (opt.9451)



alluminio finitura verde lichene (opz.8463)
aluminium lichen green
finish (opt.8463)



alluminio finitura bianco caldo (opz.7401)
aluminium warm white
finish (opt.7401)



alluminio finitura rosa quarzo (opz.8171)
aluminium quartz
pink finish (opt.8171)

Avanguardia Tecnologica

CUTTING-EDGE TECHNOLOGY

La Ditta BLUM fornisce eccellenti sistemi estraibili e di ammortamento dei cassetti e delle ante, inseriti di serie in tutti i modelli Creo Kitchens. In Blum tutto gira intorno al movimento, l'obiettivo è la soddisfazione duratura dei clienti CREO Kitchens, con prodotti che convincono per il funzionamento impeccabile, l'apprezzato design e la lunga durata, standard qualitativi applicati anche ai servizi.

BLUM provides excellent pull-out and soft-closing door and drawer systems. These are fitted as standard on all Creo Kitchens models.

At Blum everything revolves around movement; the aim is to provide CREO Kitchen customers with long-lasting satisfaction. This is achieved through products with impeccable functionality, good design, long life and high quality standards not only for products but also for services.



Progettazione e AD:
uff. ricerca e sviluppo
Lube Service&Engineering s.r.l.
PHOEM Design



100%
MADE IN ITALY
WITH LOVE

Realizzazione grafica:
uff. marketing
Lube Service&Engineering s.r.l.
PHOEM Design

I campioni e i colori riprodotti sono puramente indicativi, la rappresentazione in stampa può alterare la tonalità dei colori, le misure sono di massima, per qualsiasi riferimento vedi listino prezzi. The samples and colours reproduced here are purely indicative as their representation in print can change the shades of the colours. Measurements are approximate, see the price list for all references. L'azienda è a disposizione degli aventi diritto per le eventuali fonti iconografiche non identificate. The company is at the disposal of those entitled to any iconographic sources not identified.

3D rendering:
PHOEM Design
1FRAMERENDER

Selezioni e stampa:

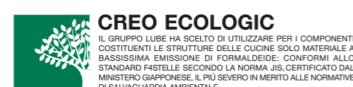

CREOKITCHENS

LUBE INDUSTRIES SRL
via dell'Industria, 4 - 62010 Treia (MC) ITALY
PIVA e Cod. Fisc. 01504060433

tel +39 0733 84.01 (ra)
fax + 39 0733 84.02.22 - 0733 84.03.33
www.creokitchens.it
info@creokitchens.it