

STRUTTURA LEGNO/METALLO



SLIDE CONSOLLE

TAVOLO / TABLE

TAVOLO "SLIDE CONSOLLE" ALLUNGABILE CON PROLUNGHE ESTERNE CON CUSTODIA
GAMBE 8X8 LEGNO PLACCATE O TINTE A COLORE
PIANO SP. 8 LAMINATO E FENIX FOLDING

"SLIDE CONSOLLE" EXTENDIBLE TABLE WITH EXTERNAL EXTENSIONS WITH CASE
8X8 PLATED OR COLOR DYED WOOD LEGS
8 TH. LAMINATE AND FENIX FOLDING TOP

CUSTODIA PER ALLUNGHI
EXTENSIONS CASE

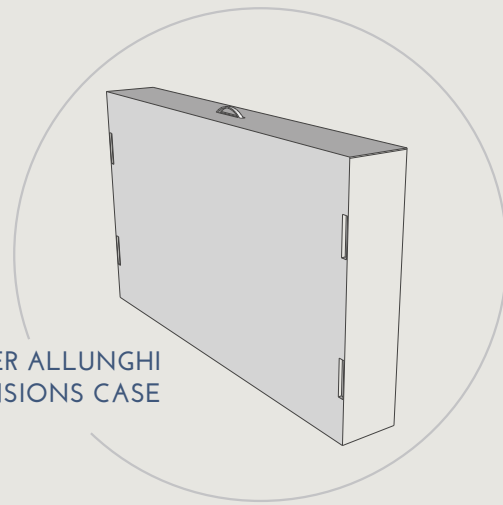

50 X 90 H 76 N.3 PROLUNGHE DA 45
50 X 90 H 76 N.3 EXTENSIONS CM 45

50 X 90 H 76 N.6 PROLUNGHE DA 45
50 X 90 H 76 N.6 EXTENSIONS CM 45

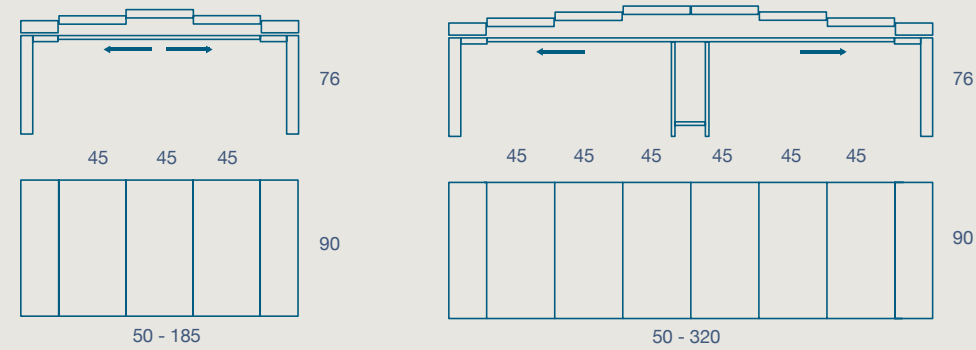

50 X 120 H 76 N.3 PROLUNGHE DA 45
50 X 120 H 76 N.3 EXTENSIONS CM 45

50 X 120 H 76 N.6 PROLUNGHE DA 45
50 X 120 H 76 N.6 EXTENSIONS CM 45

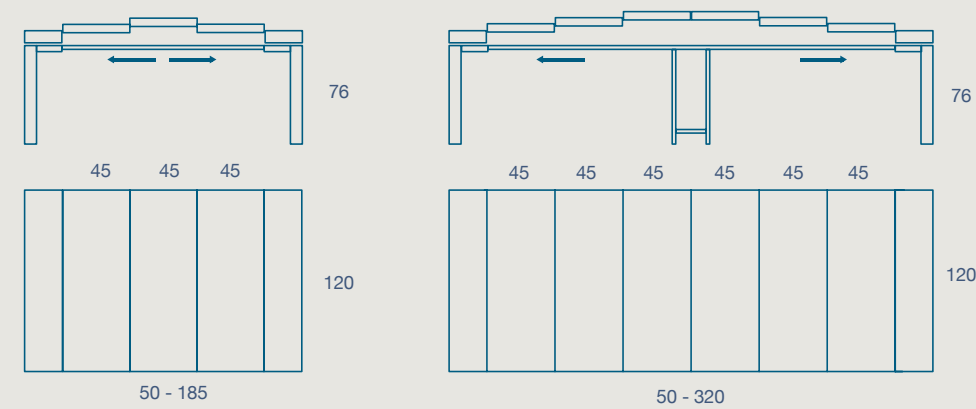

SLIDE CONSOLLE



SEDIA SIET
SIET CHAIR

NB. NELLA VERSIONE ALLUNGATA IL PIANO PUÒ SUBIRE UN ABBASSAMENTO FINO A 7MM DA NON CONSIDERARE COME DIFETTO E QUINDI NON CONTESTABILE
PLEASE NOTE: IN THE EXTENDED VERSION, THE TOP CAN BE LOWERED UP TO 7MM, NOT TO BE CONSIDERED A DEFECT AND THEREFORE NOT QUESTIONABLE

STRUTTURA LEGNO/METALLO



LAMINATO



FENIX

SLIDE CONSOLLE



CODICE / CODE

DIMENSIONI / DIMENSIONS

08SD093L	50X90 Allungabile 185 H 76 / 50X90 Extendable 185 H 76
08SD096L	50X90 Allungabile 320 H 76 / 50X90 Extendable 320 H 76
08SD123L	50X120 Allungabile 185 H 76 / 50X120 Extendable 185 H 76
08SD126L	50X120 Allungabile 320 H 76 / 50X120 Extendable 320 H 76

FINITURE STRUTTURA E PIANO LAMINATO
LAMINATE STRUCTURE AND TOP FINISHES

FINITURE STRUTTURA E PIANO FENIX
FENIX STRUCTURE AND TOP FINISHES

FINITURE LAMINATO FENIX E MELAMINICO

LAMINATE, FENIX AND MELAMINE FINISHES

FINITURE LAMINATO

LAMINATE FINISHES



IMMAGINA

NOEMI

PLANKY

VELVET

OSSIDATA "T"

LUNA

WRAKY

URBAN

TOUCH

DECORATIVO UTILIZZATO NEI TOP STRATIFICATO HPL

DECORATION USED IN THE LAYERED HPL TOP

KER

SMART

FINITURE FENIX

FENIX FINISHES

FINITURE MELAMINICO

MELAMINE FINISHES



MYA

KYRA VINTAGE



FINITURE LAMINATO

LAMINATE FINISHES

LUBE **IMMAGINA PLUS** (FINITURE COME ANTA)
(DOOR FINISHES)

FINITURA OSSIDATA "A"

OXIDIZED "A" FINISH



FINITURA MATT

MATT FINISH

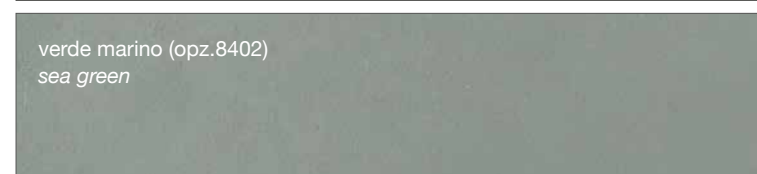
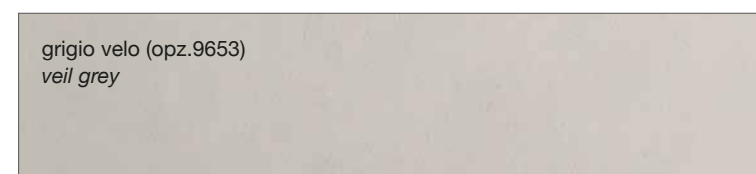
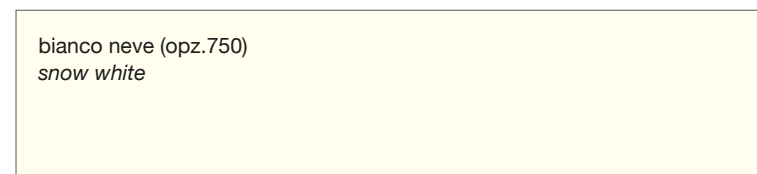
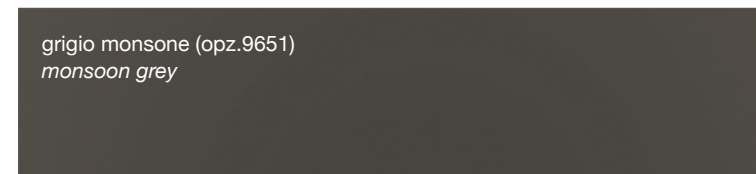

FINITURA SPAZZOLATA

BRUSHED FINISH

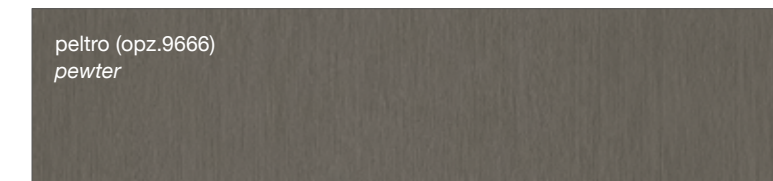

FINITURA OPACA MALTA

MORTAR MATT FINISH

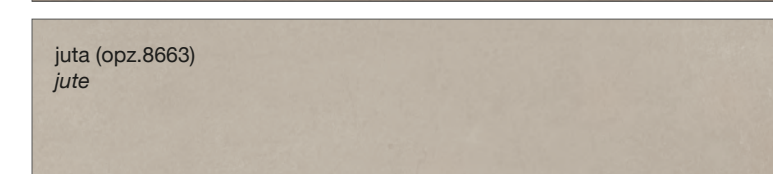
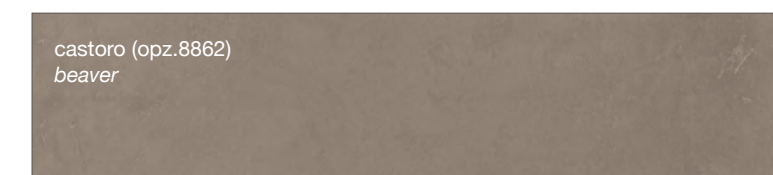
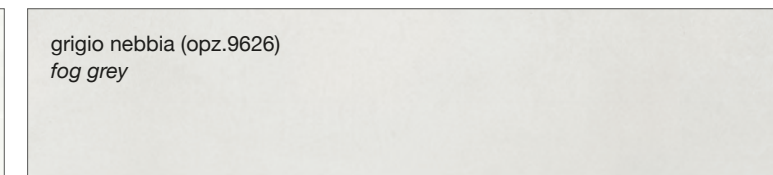
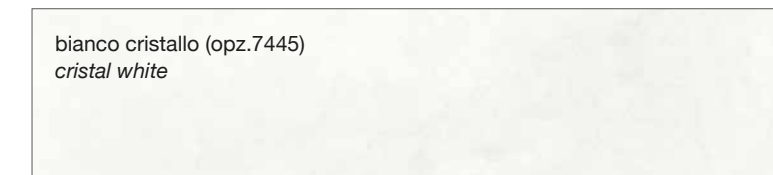

FINITURA OPACA CANSIGLIO

CANSIGLIO MATT FINISH



FINITURA MARMONIZZATA

MARbled FINISH



FINITURA OPACA MATERICA

TEXTURED MATT FINISH



FINITURA OPACA SINCRO PORO EFFETTO LACCATO

SYNC PORE LACQUERED EFFECT MATT FINISH



FINITURA OPACA SINCRO PORO EFFETTO LEGNO

SYNC PORE WOOD EFFECT MATT FINISH



FINITURA OPACA PORO APERTO A REGISTRO

REGISTER OPEN-PORE FINISH



NOEMI

(FINITURE COME ANTA)
(DOOR FINISHES)

FINITURA SETA

MATT COLOURS WITH SKIN FINISH



FINITURA SINCRO PORO

MATT COLOURS WITH SYNC PORE FINISH

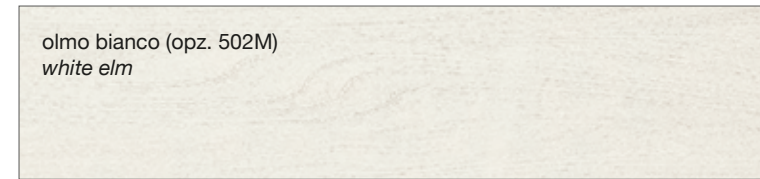

FINITURE COME TOP LAMINATO

LAMINAM COUNTERTOP FINISHES

FINITURA PLAMKY

PLAMKY FINISH

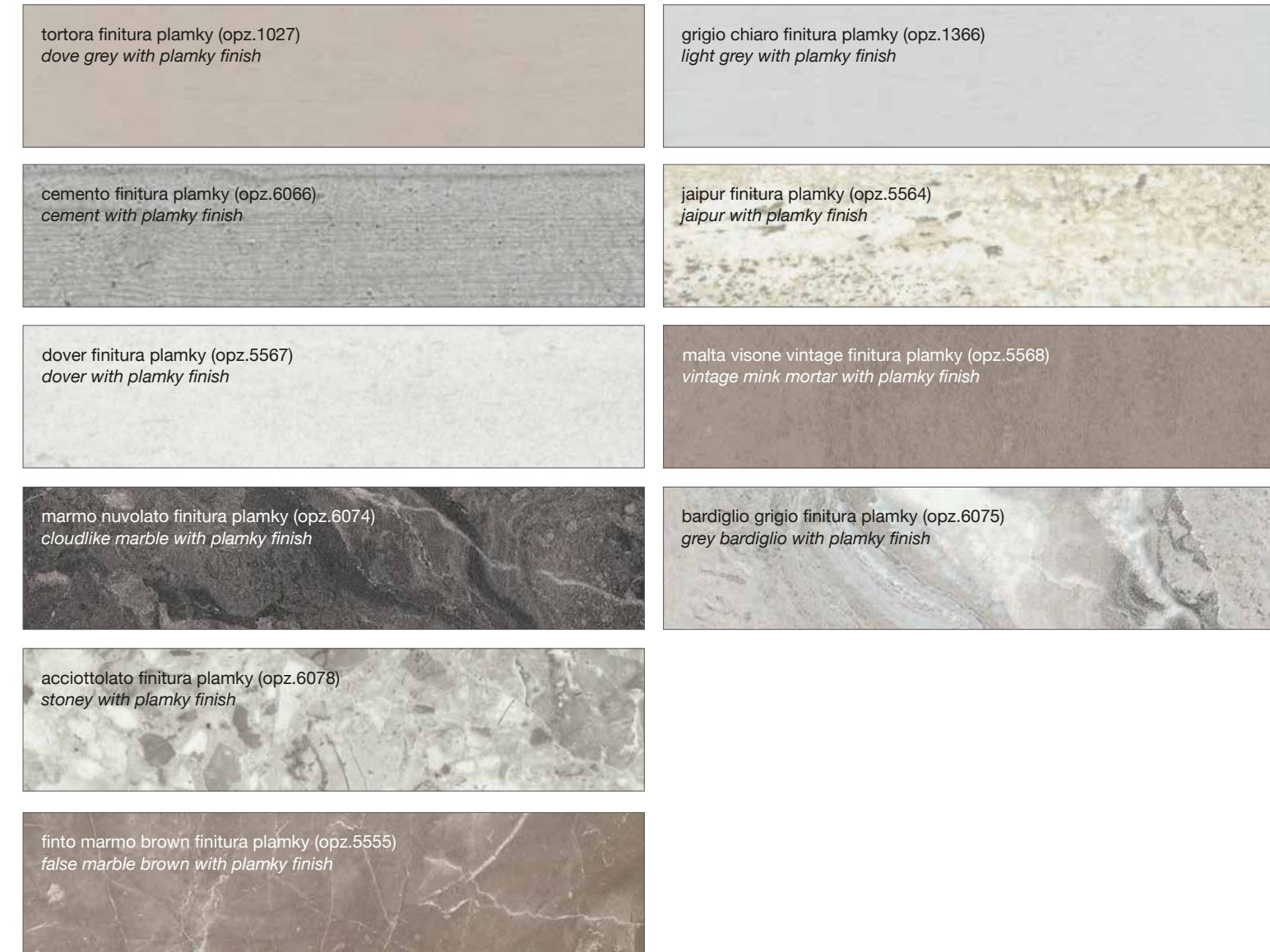

FINITURA VELVET

VELVET FINISH



FINITURA OSSIDATA "T"

OXIDIZED FINISH



FINITURA LUNA

LUNA FINISH

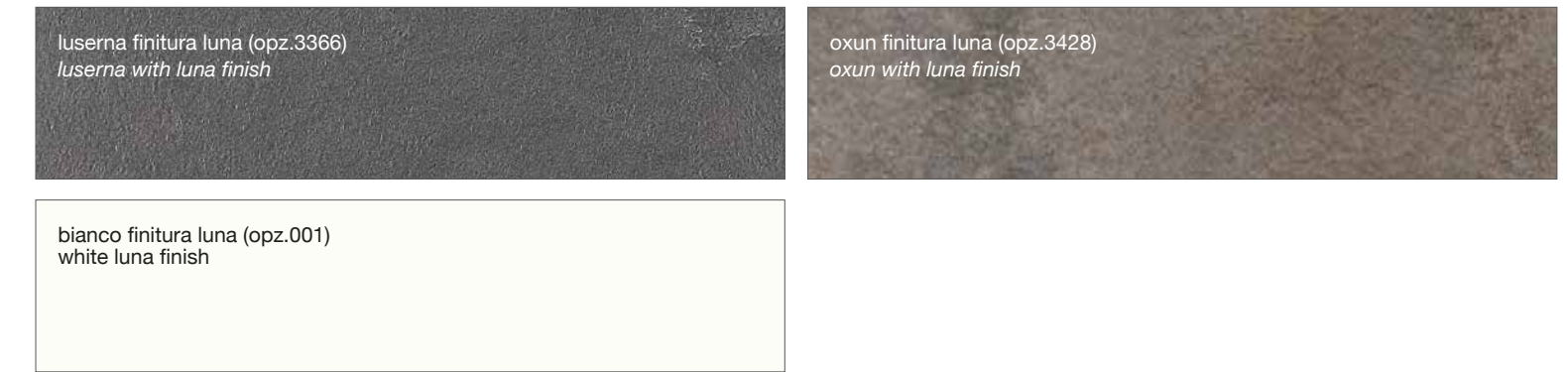

FINITURA WRAKY

WRAKY FINISH



FINITURA URBAN

URBAN FINISH

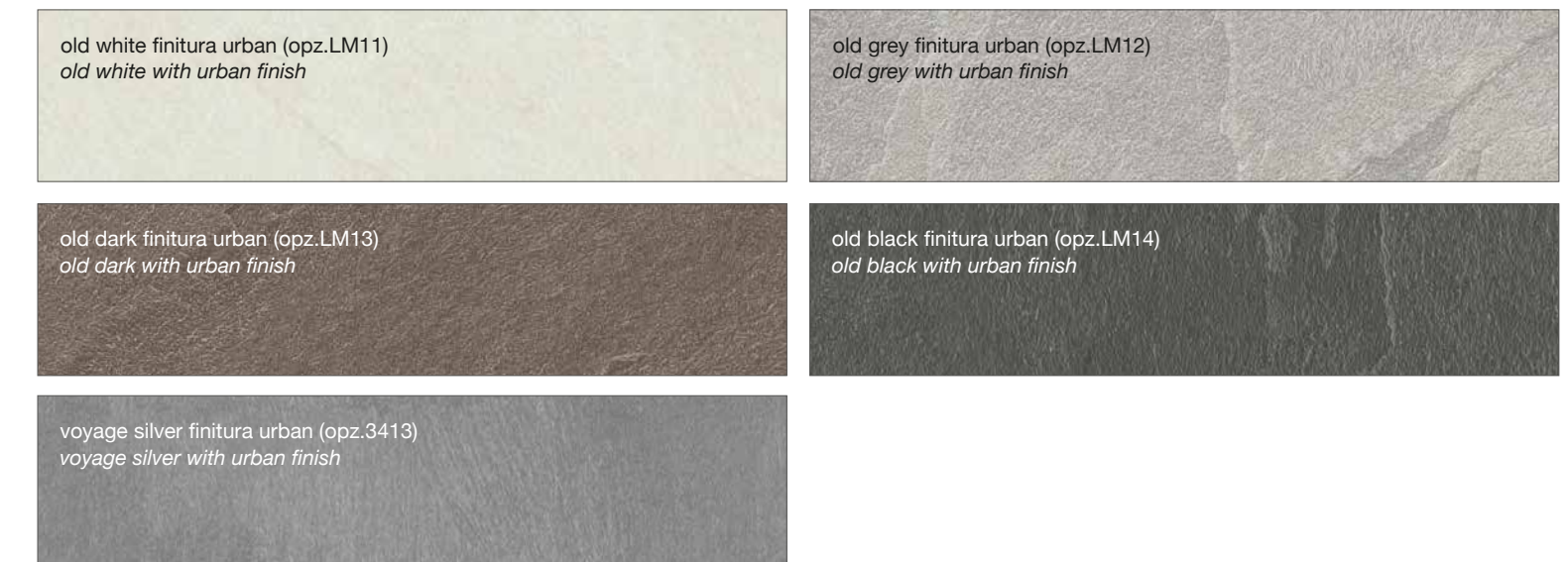

FINITURA TOUCH

TOUCH FINISH



FINITURA KER

KER FINISH



imperial (opz.3452)
imperial

FINITURA SMART

SMART FINISH



marmo baron (opz.9632)
baron marble

FINITURA COME DECORATIVO UTILIZZATO NEI TOP STRATIFICATO HPL

FINISH AS DECORATION USED IN THE LAYERED HPL TOP

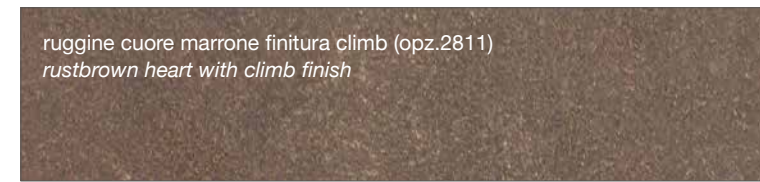

ruggine cuore marrone finitura climb (opz.2811)
rustbrown heart with climb finish

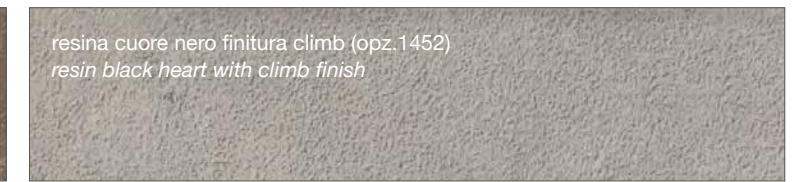

resina cuore nero finitura climb (opz.1452)
resin black heart with climb finish

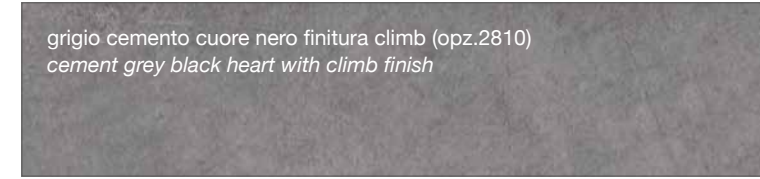

grigio cemento cuore nero finitura climb (opz.2810)
cement grey black heart with climb finish



ossido cuore nero finitura holed (opz.3690)
oxide black heart with holed finish



quercia cuore marrone finitura wood (opz.788)
oak brown heart with wood finish

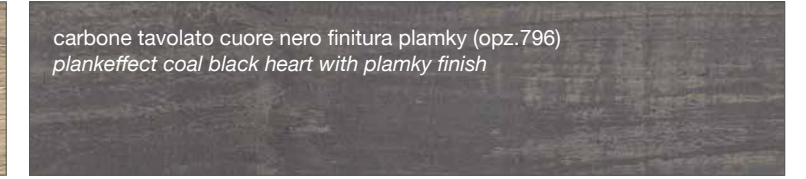

carbone tavolato cuore nero finitura plamky (opz.796)
plankeffect coal black heart with plamky finish



oxun cuore nero finitura luna (opz.3428)
oxun black heart with luna finish

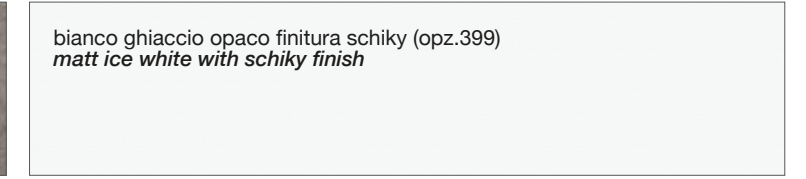

bianco ghiaccio opaco finitura schiky (opz.399)
matt ice white with schiky finish



fumo opaco finitura fenix NTM™ (opz.0718)
matt smoke fenix NTM™ finish



nero opaco finitura fenix NTM™ (opz.0720)
matt black fenix NTMTM finish



perlato cuore nero finitura ker (opz.3443)
pearly black heart ker finish

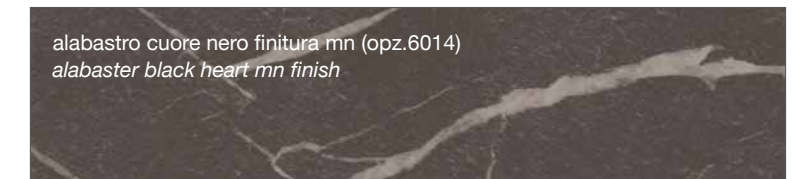

alabastro cuore nero finitura mn (opz.6014)
alabaster black heart mn finish

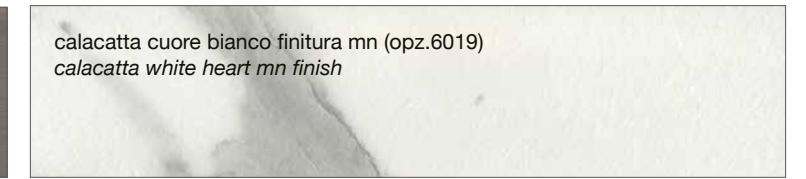

calacatta cuore bianco finitura mn (opz.6019)
calacatta white heart mn finish

FINITURE FENIX

FENIX FINISHES

FINITURA FENIX NTM™

FENIX NTM™ FINISHES

<p>zinco doha (opz. 2628) <i>zinco doha</i></p>	<p>titanio doha (opz. 2638) <i>titanio doha</i></p>
<p>bronzo doha (opz. 2629) <i>doha bronze</i></p>	<p>piombo doha (opz. 2630) <i>piombo doha</i></p>
<p>bianco caldo (opz. 0032) <i>warm white</i></p>	<p>castoro (opz. 0717) <i>beaver</i></p>
<p>fumo (opz. 0718) <i>smoke</i></p>	<p>nero (opz. 0720) <i>black</i></p>
<p>grigio bromo (opz. 0724) <i>bromine grey</i></p>	<p>grigio antrim (opz. 0752) <i>antrim grey</i></p>
<p>cacao orinoco (opz. 0749) <i>orinoco cacao</i></p>	<p>beige arizona (opz. 0748) <i>arizona beige</i></p>
<p>verde comodoro (opz. 0750) <i>comodoro green</i></p>	<p>rosso jaipur (opz. 0751) <i>jaipur red</i></p>
<p>grigio efeso (opz. 0721) <i>efeso gray</i></p>	

FINITURE MELAMINICO

MELAMINE FINISHES

CREO KYRA VINTAGE

MELAMINICO

MELAMINE

<p>abete nordico bianco (opz. 4406) <i>white nordic fir</i></p>
<p>rovere naturale vintage (opz. 5310) <i>vintage natural oak</i></p>