

LUVJ

TAVOLO / TABLE

TAVOLO "LUVJ" ALLUNGABILE.
STRUTTURA E GAMBE A PONTE 6X6 METALLO VERNICIATO
PIANO SP. 2 LAMINATO E FENIX

"LUVJ" EXTENDIBLE TABLE.
6X6 PAINTED METAL FRAME AND BRIDGE LEGS
2 TH. LAMINATE AND FENIX TOP



METALLO



LAMINATO



FENIX

120 X 80 H 75 N.2 PROLUNGHE DA 45
120 X 80 H 75 N.2 EXTENSIONS CM 45

140 X 80 H 75 N.2 PROLUNGHE DA 45
140 X 80 H 75 N.2 EXTENSIONS CM 45

160 X 80 H 75 N.2 PROLUNGHE DA 45
160 X 80 H 75 N.2 EXTENSIONS CM 45

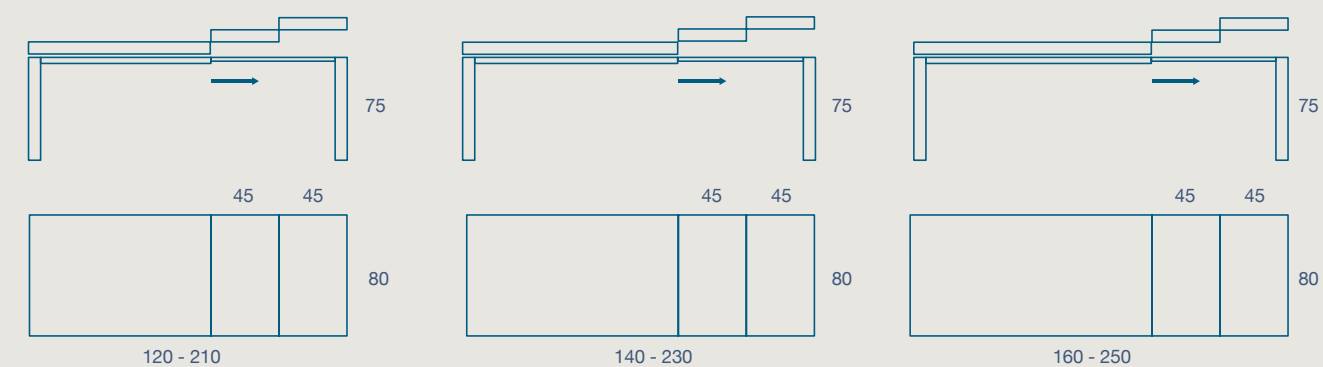

120 X 90 H 75 N.2 PROLUNGHE DA 45
120 X 90 H 75 N.2 EXTENSIONS CM 45

140 X 90 H 75 N.2 PROLUNGHE DA 45
140 X 90 H 75 N.2 EXTENSIONS CM 45

160 X 90 H 75 N.2 PROLUNGHE DA 45
160 X 90 H 75 N.2 EXTENSIONS CM 45

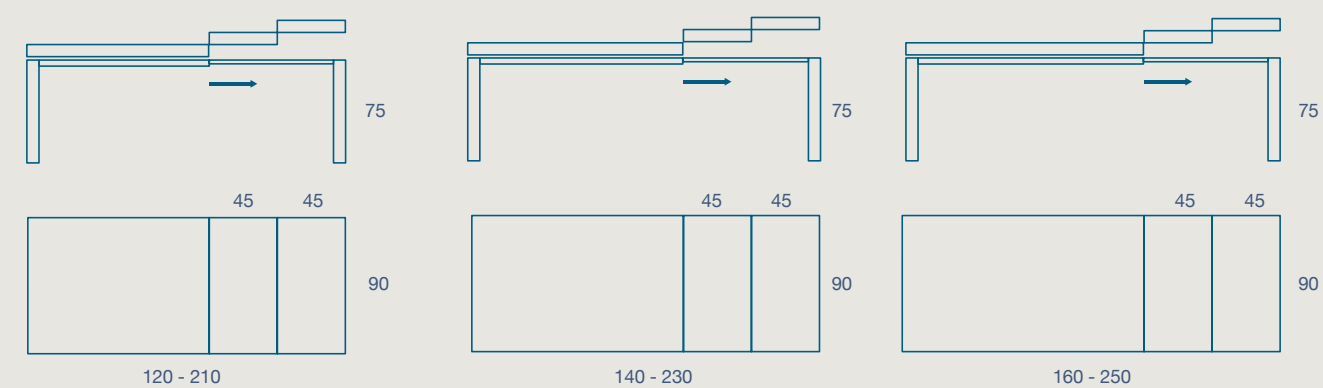

SEDIA RIBES
RIBES CHAIR



METALLO



LAMINATO



FENIX



DETTAGLIO ALLUNGO
EXTENSION DETAIL

FINITURE STRUTTURA METALLO VERNICIATO OPACO
MATT PAINTED METAL STRUCTURE FINISHES



bianco assoluto (opz. 740)
absolute white



silver dark (opz. 9507)
silver dark

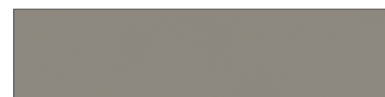

grigio selce (opz. 9550)
flint gray



nero (opz. NE)
black



grigio kenia (opz. 9501)
kenya grey



ghisa (opz. 9509)
cast iron

CODICE / CODE

DIMENSIONI / DIMENSIONS

08LJ12L	120X80 Allungabile 210 H 75 / 120x80 Extendable 210 H 75
08LJ14L	140X80 Allungabile 230 H 75 / 140x80 Extendable 230 H 75
08LJ16L	160X80 Allungabile 250 H 75 / 160x80 Extendable 250 H 75
08LJ22L	120X90 Allungabile 210 H 75 / 120x90 Extendable 210 H 75
08LJ24L	140X90 Allungabile 230 H 75 / 140x90 Extendable 230 H 75
08LJ26L	160X90 Allungabile 250 H 75 / 160x90 Extendable 250 H 75



FINITURE PIANO LAMINATO
LAMINATE TOP FINISHES

FINITURE PIANO FENIX
FENIX TOP FINISHES

FINITURE LAMINATO FENIX E MELAMINICO

LAMINATE, FENIX AND MELAMINE FINISHES

FINITURE LAMINATO

LAMINATE FINISHES



IMMAGINA

NOEMI

PLANKY

VELVET

OSSIDATA "T"

LUNA

WRAKY

URBAN

TOUCH

DECORATIVO UTILIZZATO NEI TOP STRATIFICATO HPL

DECORATION USED IN THE LAYERED HPL TOP

KER

SMART

FINITURE FENIX

FENIX FINISHES

FINITURE MELAMINICO

MELAMINE FINISHES



MYA

KYRA VINTAGE



FINITURE LAMINATO

LAMINATE FINISHES

LUBE **IMMAGINA PLUS** (FINITURE COME ANTA)
(DOOR FINISHES)

FINITURA OSSIDATA "A"

OXIDIZED "A" FINISH



FINITURA MATT

MATT FINISH

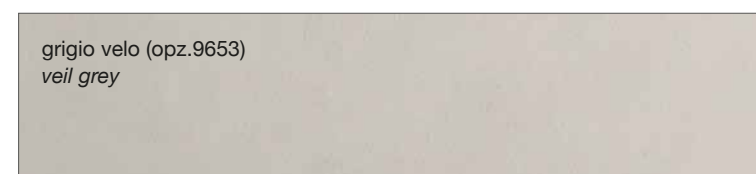
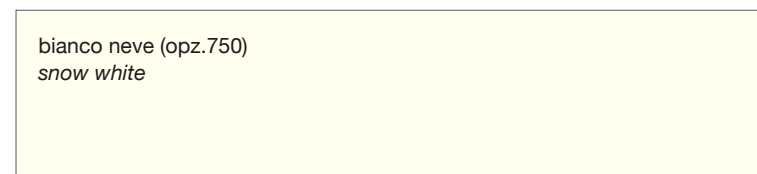
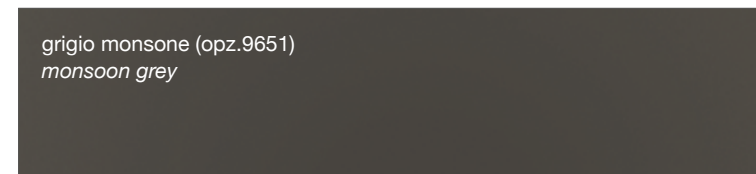

FINITURA SPAZZOLATA

BRUSHED FINISH

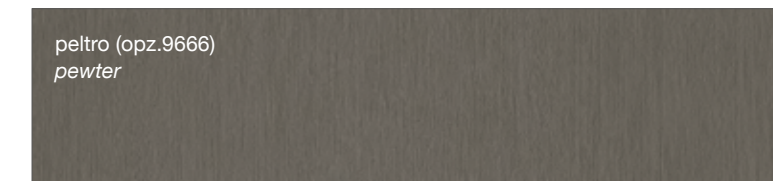

FINITURA OPACA MALTA

MORTAR MATT FINISH

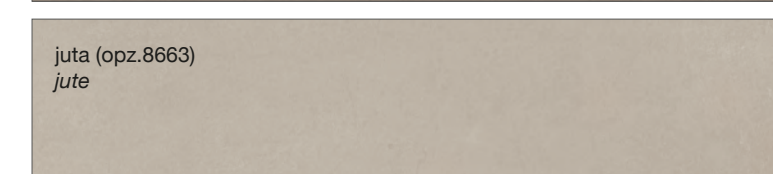
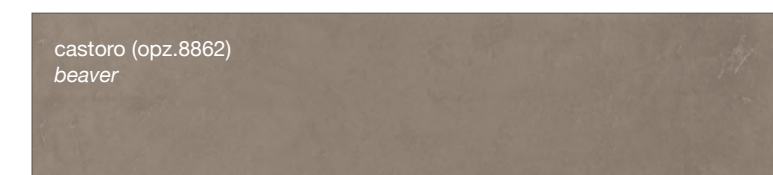
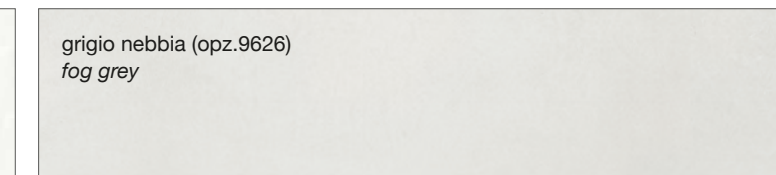
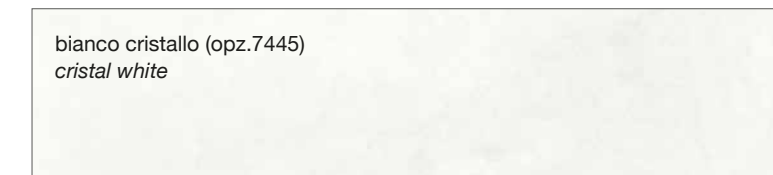

FINITURA OPACA CANSIGLIO

CANSIGLIO MATT FINISH



FINITURA MARMONIZZATA

MARbled FINISH



FINITURA OPACA MATERICA

TEXTURED MATT FINISH



FINITURA OPACA SINCRO PORO EFFETTO LACCATO

SYNC PORE LACQUERED EFFECT MATT FINISH



FINITURA OPACA SINCRO PORO EFFETTO LEGNO

SYNC PORE WOOD EFFECT MATT FINISH



FINITURA OPACA PORO APERTO A REGISTRO

REGISTER OPEN-PORE FINISH



NOEMI

(FINITURE COME ANTA)
(DOOR FINISHES)

FINITURA SETA

MATT COLOURS WITH SKIN FINISH



FINITURA SINCRO PORO

MATT COLOURS WITH SYNC PORE FINISH

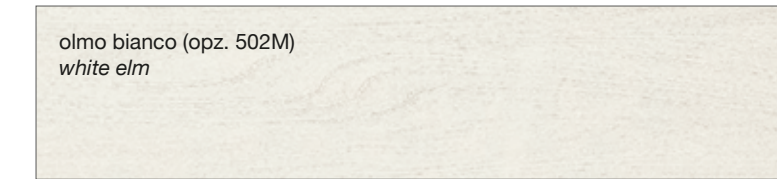

FINITURE COME TOP LAMINATO
LAMINAM COUNTERTOP FINISHES

FINITURA PLAMKY
PLAMKY FINISH



marmo nuvolato finitura plamky (opz.6074)
cloudlike marble with plamky finish

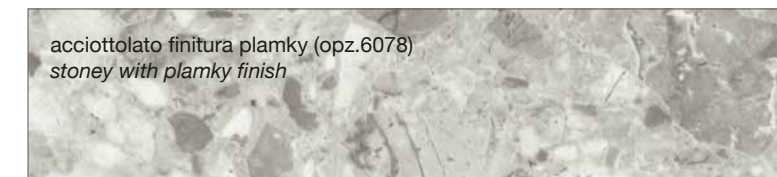

acciottolato finitura plamky (opz.6078)
stoney with plamky finish

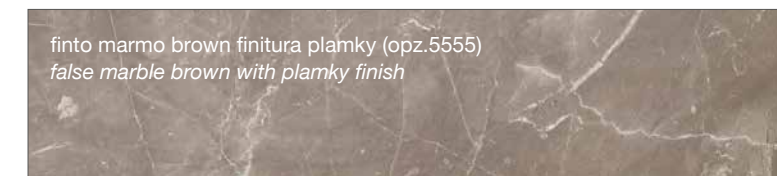

finto marmo brown finitura plamky (opz.5555)
false marble brown with plamky finish



malta visone vintage finitura plamky (opz.5568)
vintage mink mortar with plamky finish



bardiglio grigio finitura plamky (opz.6075)
grey bardiglio with plamky finish



grey finitura plamky (opz.9826)
grey with plamky finish

FINITURA VELVET
VELVET FINISH

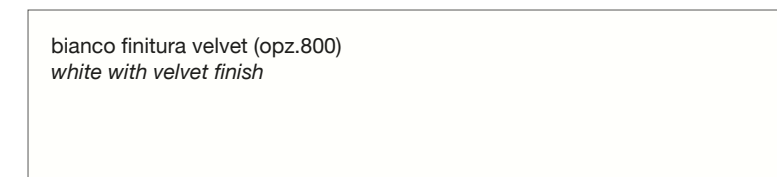

bianco finitura velvet (opz.800)
white with velvet finish

FINITURA OSSIDATA "T"
OXIDIZED FINISH

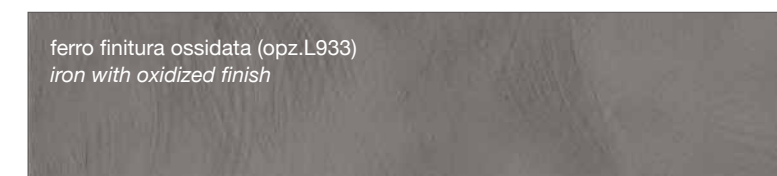

ferro finitura ossidata (opz.L933)
iron with oxidized finish

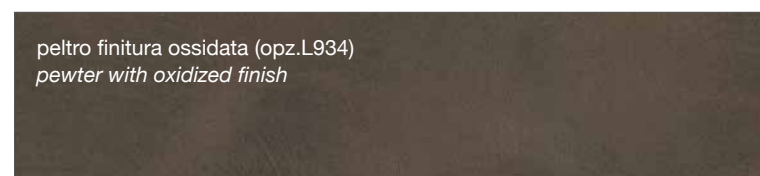

peltro finitura ossidata (opz.L934)
pewter with oxidized finish

FINITURA LUNA
LUNA FINISH



luserna finitura luna (opz.3366)
luserna with luna finish

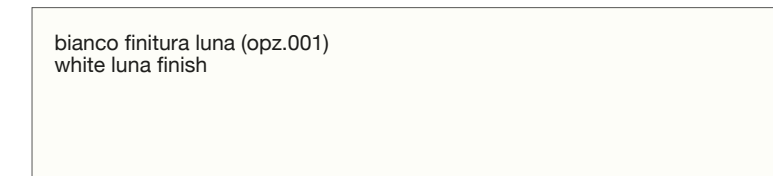

bianco finitura luna (opz.001)
white luna finish

FINITURA WRAKY
WRAKY FINISH



beton finitura wraky (opz.810)
beton with wraky finish



esterel finitura wraky (opz.811)
esterel with wraky finish

FINITURA URBAN
URBAN FINISH



old white finitura urban (opz.LM11)
old white with urban finish

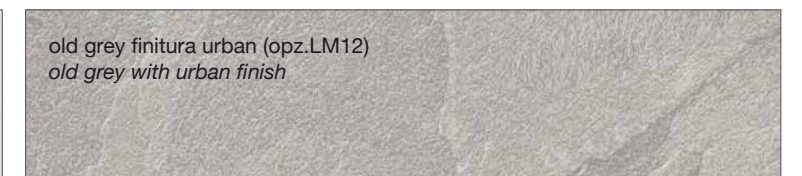

old grey finitura urban (opz.LM12)
old grey with urban finish

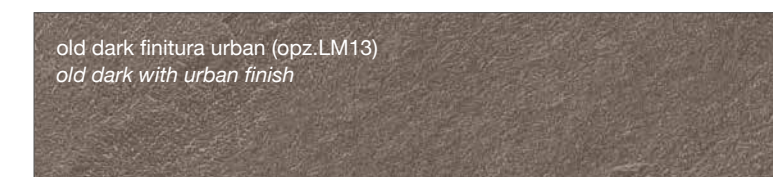

old dark finitura urban (opz.LM13)
old dark with urban finish



old black finitura urban (opz.LM14)
old black with urban finish



voyage silver finitura urban (opz.3413)
voyage silver with urban finish

FINITURA TOUCH
TOUCH FINISH

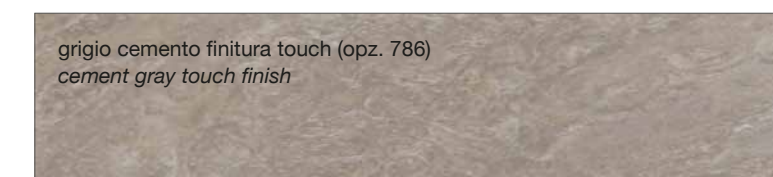

grigio cemento finitura touch (opz. 786)
cement gray touch finish

FINITURA KER

KER FINISH



imperial (opz.3452)
imperial

FINITURA SMART

SMART FINISH



marmo baron (opz.9632)
baron marble

FINITURA COME DECORATIVO UTILIZZATO NEI TOP STRATIFICATO HPL

FINISH AS DECORATION USED IN THE LAYERED HPL TOP

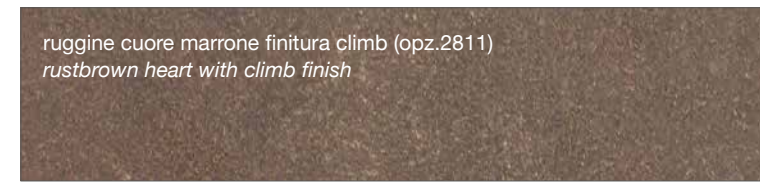

ruggine cuore marrone finitura climb (opz.2811)
rustbrown heart with climb finish

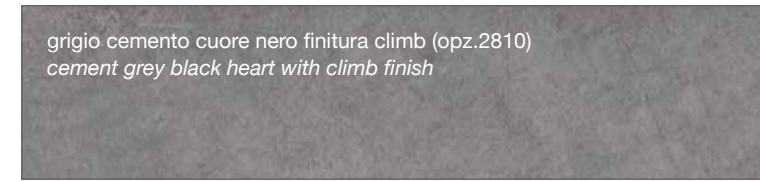

grigio cemento cuore nero finitura climb (opz.2810)
cement grey black heart with climb finish

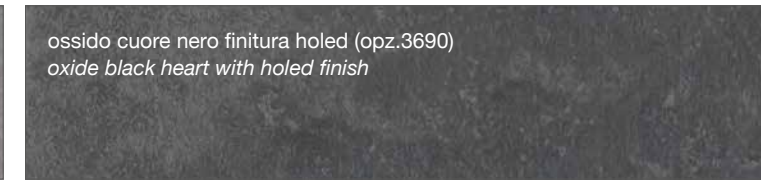

ossido cuore nero finitura holed (opz.3690)
oxide black heart with holed finish



quercia cuore marrone finitura wood (opz.788)
oak brown heart with wood finish



carbone tavolato cuore nero finitura plamky (opz.796)
plankeffect coal black heart with plamky finish

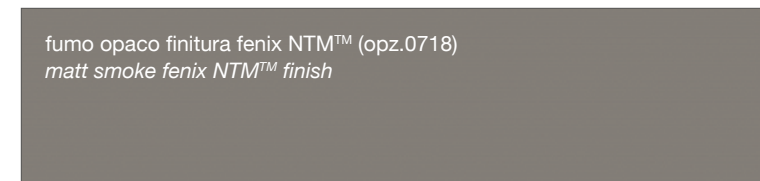

fumo opaco finitura fenix NTM™ (opz.0718)
matt smoke fenix NTM™ finish

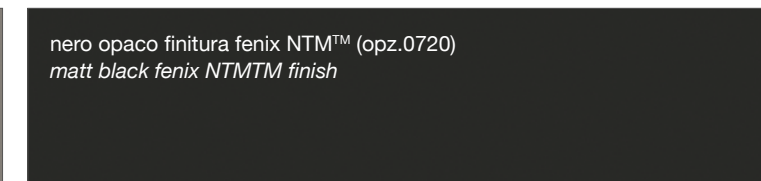

nero opaco finitura fenix NTM™ (opz.0720)
matt black fenix NTMTM finish

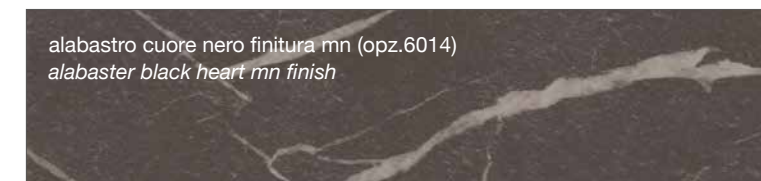

alabastro cuore nero finitura mn (opz.6014)
alabaster black heart mn finish



perlato cuore nero finitura ker (opz.3443)
pearly black heart ker finish

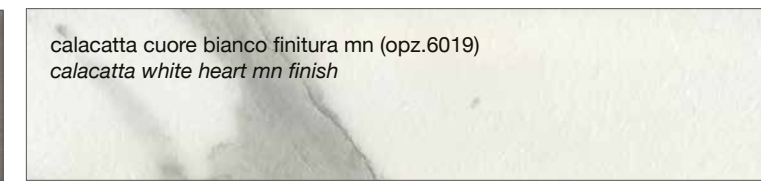

calacatta cuore bianco finitura mn (opz.6019)
calacatta white heart mn finish

FINITURE FENIX

FENIX FINISHES

FINITURA FENIX NTM™

FENIX NTM™ FINISHES

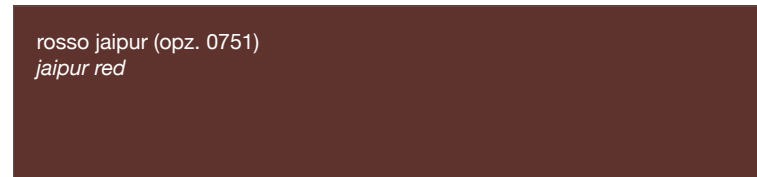
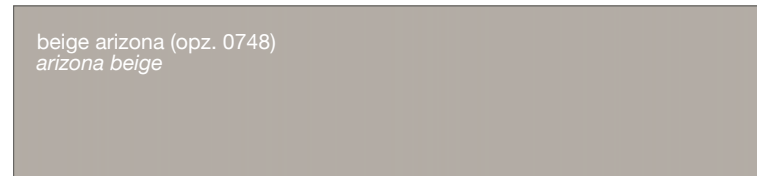
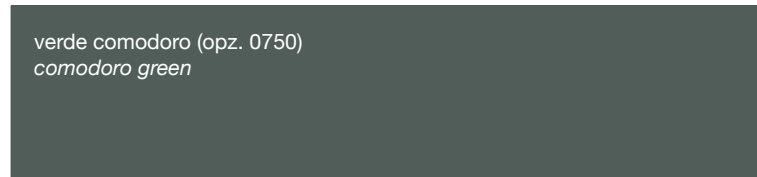
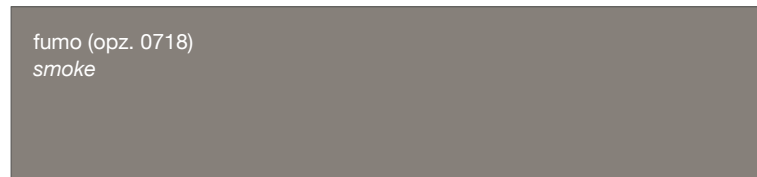

FINITURE MELAMINICO

MELAMINE FINISHES

CREO KYRA VINTAGE

MELAMINICO

MELAMINE

